

KENDRICK GAZETTE

U. of I. Library

VOLUME 77

KENDRICK LATAH COUNTY, IDAHO THURSDAY, NOVEMBER 30, 1967

NO. 48

JULIAETTA DOINGS IN PAST WEEK

MRS. WM. LUBLOW
Phone 276-8506

Candler Family Gathers

A Candler family gathering was held Thanksgiving Day with 63 family members enjoying a bountiful pot-luck dinner at the Rebekah Lodge Hall.

Those present were Mr. and Mrs. P. G. Candler, Mr. and Mrs. Ben Westendahl, Mrs. Arnie Zumhofe, Mr. and Mrs. Al Westendahl and Mr. and Mrs. James Candler and family, all of Kendrick; the Bob Chilberg family of Cedar ridge; Mrs. Lloyd Candler, Mr. and Mrs. Jerry Gustin and family and the Neale Hoisington family, all of Juliaetta; Mr. and Mrs. Neil Candler, the Don Strong family and Linda Adair, all of Potlatch; the Don Candler family and Jack Brady, all of Bovill; Mr. and Mrs. Jim Jones and family of Deary; the Gilbert Candler family of Clarkston; the Duane Candler family of Asotin, and Feryl Candler, who was home on leave from the navy, and Mr. and Mrs. Tom Bain and family of Moscow.

Charles Hick Dies Monday

Charles H. Hicks, 78, Juliaetta, a retired livestock buyer, died Monday, Nov. 27, at 4:36 a. m. at the St. Joseph's Hospital in Lewiston of pneumonia, complicated by the infirmities of age. He had been a patient there for two weeks.

Mr. Hicks was born Jan. 20, 1889, at Dry Ridge, Kentucky, and spent his early years in Indiana. He lived at Union City, Indiana until 1926, when he moved to Leland. There he farmed with his brother, George Hicks.

In 1932 he moved to Juliaetta. He was a stock buyer for the Twin City Sales Yard, Lewiston. He retired in 1952.

Hicks married Minnie Kite of Juliaetta on Feb. 9, 1945. In addition to his widow he is survived by a brother, Harry H. Hicks, San Diego, Calif.; two stepdaughters, Mrs. Frank Barton and Mrs. Sherman Schrock, both of Lewiston; two grandchildren and a great-granddaughter.

Rosary was recited at 7:30 p. m. Tuesday at the Vassar-Rawls Funeral Home, Lewiston, with the Rev. Fr. Howard Moran, pastor of St. Stanislaus Catholic Church, officiating.

Juliaetta Baby Wins Contest

Congratulations go to a Juliaetta baby, Nancy Cook, for winning the Baby Contest.

Lighting Candles

The Methodist Sunday School is lighting a candle on their "Advent Wreath" each Sunday in the sanctuary, before church.

Thanksgiving Happenings

Thanksgiving dinner guests in the Ervin Mabbott home were Mr. and Mrs. Gene Burch and sons of Pierce and Mr. and Mrs. Tom Mabbott and children.

Mr. and Mrs. Donald Johns and children and Mr. and Mrs. John Groseclose and children, Lewiston; Mr. and Mrs. Douglas Johns and children and Ed Sampson were the Thanksgiving dinner guests in the Adrian Johns home.

Thanksgiving Day guests in the J. M. Murray home were Mrs. Hazel Fuller, Northport, Wn.; Mr. and Mrs. George A. Jones, Orofino and Mr. and Mrs. Clark Fuller and children, also Orofino; Mr. and Mrs. Vernon L. Granlund and children, Troy; Mr. and Mrs. J. R. Torgerson and children, The Dalles, Ore.; Miss Joan Rankin, Kllickit, Wn.; Mrs. Ebba Granlund and Gordon Granlund of Lewiston. There were 23 present in all.

Week-end and Thanksgiving guests in the Harold Freeman home were his parents from Hermiston, Ore., and Mr. and Mrs. Wm. Whitsett and family, The Dalles, Ore.

Mr. and Mrs. Ike Ostman were Thanksgiving dinner guests in the Ernest Wing home.

Thanksgiving visitors in the Helen Groseclose home were Mr. and Mrs. James Groseclose and children, Mr. and Mrs. Eugene Feucht and family and Don Groseclose, all of Lewiston. Mrs. Helen Groseclose received a phone call from her daughter in Portland, telling her she was now a great-grandmother, a son having been born to Mr. and Mrs. Don Simmons that day.

Mr. and Mrs. Bruce Sherman and Jill and Mr. and Mrs. Chuck Noble visited Mr. and Mrs. Jack Sherman at Ft. Jones, Calif., over the Thanksgiving week-end.

Randy Noble received facial cuts and bruises while working at the gas station, Saturday.

Mr. and Mrs. Pete Tschantz of Tacoma, Wn., returned home Friday morning after making a few days visit here with his brother-in-law and sister, Mr. and Mrs. Rufus Fairfield. Thanksgiving Day dinner guests were Mr. and Mrs. Pete Tschantz; Henry Tschantz, Southwick. Evening callers were Mr. and Mrs. Robert Tschantz of Lewiston and Joe Tschantz of Spokane.

Mr. and Mrs. Huse Groseclose were Thanksgiving guests of Mr. and Mrs. Wally Lane, Lewiston.

Mr. and Mrs. Rich Smith and family and Mrs. L. Hayes were dinner guests Thanksgiving of Mr. and Mrs. Harlan Bunch, Ahsanka.

(Continued on Page 5)

CAR RESCUED

Dick Smith of Juliaetta, was ascending the Hubbard Gulch grade on Friday evening, when he met a descending car which forced him off the road — leaving his vehicle with both front wheels hanging over the edge.

It was pulled back onto the road by the wrecker from the Kendrick Welding & Machine Shop. There were no personal injuries and the car suffered only minor damage.

DOINGS AT K. H. S. IN PAST AND COMING WEEK

Swing Concert Given

The Swing Concert, a band benefit, was given at the High School on Tuesday evening of this week. It was well attended. It was sponsored by the Music department of the high school.

Coaches Wanted

All men parents, who are interested in coaching Little League basketball this year, are asked to attend the planning meeting at the High School cafeteria at 7:30 this Thursday, Nov. 30.

To Attend Dinner

The teachers of Joint Dist. No. 283 will be attending the I. E. A. Regional meeting and 6:30 dinner at Moscow on Wednesday, Nov. 29.

Film On Smoking

On Wednesday afternoon a film on "Smoking" will be shown to high school and junior high students throughout the afternoon, as classes permit.

Basketball Tournament

Friday, the Genesee Invitational basketball tournament will be held there, for participation by neighboring schools. The Kendrick Tigers will be taking part.

Band Exchange

Friday, the Music Department will take part in the band exchange concert at Lapwai, at 11:00 a. m. The Lapwai exchange concert will be held here the following Tuesday, or Dec. 5th.

To Take Tests Tuesday

Tuesday, Dec. 5th, the Home Economics seniors under the direction of Mrs. Norman Lewis, will be taking the annual "Betty Crocker" tests at the high school.

National Assemblies Program

On Thursday of this week, at 12:40 p. m., the National School Assemblies will present Bob Wood with "Dramatic Adventures With Chalk" at the High School. The entertainment is open to the public.

R. G. BLANKENSHIP DIES NOV. 20TH

A Lenore resident, Raymond G. Blankenship, 68, died at St. Joseph's Hospital at 6:14 a. m., Monday, Nov. 20. He had been hospitalized for two weeks and had been suffering from arthritis for many years. Cause of his death was not immediately determined.

He was born at Troy, Idaho, on May 2, 1899, to Mr. and Mrs. Thomas Blankenship. He was married to Edith Hewett at Orofino, July 25, 1920, and the couple farmed in the Teakean area. He also had farmed the John Darby ranch on Cedar ridge for many years, leaving there in 1956.

He was a member of the Evergreen Grange at Teakean. Survivors are his widow at home; a son, Delmar, Weippe; a brother, Roy J. Blankenship, Clarkston, and three grandchildren.

Funeral services were held at 1:30 p. m. Wednesday at the Merchant Funeral Home in Clarkston, with Rev. Harold Pressnall of the U. E. Church, Lenore, officiating. Mrs. DeVoe Miller was the musician.

Palbearers were Gifford Brown, Orval Choate, Cecil Choate, O. C. Vannoy, William Brown and Fred Cole. Interment was in Vineland Cemetery, Clarkston.

KENDRICK GRANGE HEARS OF INDIA

Miss Hermina Meyer, attired in the native dress of a woman of India, narrated slides of India for Grange members during the lecturer's hour on Tuesday evening, Nov. 7th.

The slides were most interesting, as farm scenes, crops and the methods of harvesting were depicted. Other slides shown were of the hospital where Miss Meyer has been stationed for the past nine years.

Mrs. Roy Glenn was appointed Community Progress chairman for 1968. Plans were developed for the annual Christmas party. An invitation was extended to youngsters to take part in the program.

The Hobby Table proudly displayed the items that had taken prizes at the State Grange.

ENTERS HOSPITAL

E. M. (Bill) White entered the Gritman Memorial Hospital on Sunday to undergo tests and diagnosis.

POTLATCH WATER WANTED BY U. OF I. AT MOSCOW

Mel Hamilton, Juliaetta, called the attention of the Gazette to the following legal notice, which appeared in the Daily Idahoan, Moscow, under date of Monday, Nov. 20, 1967: We quote verbatim:

"Notice of Application for Permit To Appropriation of the Public Waters of the State of Idaho

"In accordance with the provisions of Section 42-203, Idaho Code

"Notice is hereby given that the Regents of the University of Idaho of Moscow, Idaho, has made application No. 42127 on May 15, 1967, to appropriate 33.91 cubic feet per second of the East Fork of the Potlatch River and the Potlatch River, for domestic purposes for the University of Idaho.

"That the points of diversion are located in 1) SW 1/4, Sec. 32, T. 41 N. R. 1 E. and 2) NW 1/4, Sec. 34, T. 40 N. R. 1 W. B. NW.

"That the place of use is the University of Idaho, City of Moscow, Idaho.

"That any protests against the approval of this application must be filed in the Department of Reclamation of Boise, Idaho, within forty (40) days from the date of this notice and such protest shall state the name and address of the protestant, and shall clearly set forth his objection to the approval of said application.

"Dated this 14th day of November, 1967.

"R. Keith Higginson, State Reclamation Engineer.

"Date of first publication November 20, 1967.

"Date of last publication November 21, 1967.

"Last date for protest December 26, 1967."

"Nov. 20, 21, 1967."

As near as can be determined from available maps at this time, and without knowledge of the exact points at which the University proposes to take the 33.91 cubic feet per second — it would seem that it is the East Fork above the City of Bovill, and again just above the Boulder Creek camp grounds, taking, apparently, all available water from both streams, just after Boulder Creek enters the Potlatch.

Now, should we have another dry summer such as the one just past — how much water would be left in the Potlatch River to supply those who now hold valid water rights? There is a serious doubt if there would be any!

Among those holding valid water rights, to our knowledge, in this section are:

Gem State Lumber Co., Juliaetta, where the water is used for log preservation, fire protection, mill operation, etc.

Juliaetta Dairy, Juliaetta, where the water is used for irrigation, barn sanitation, etc.

Mr. and Mrs. Ervil Woody, Juliaetta, where the water is used for irrigation, etc.

Phil Johns, Juliaetta, irrigation, etc.

At Kendrick:

Mr. and Mrs. Herman Schupfer and Mrs. W. A. Watts, irrigation.

Mr. and Mrs. Paul Lind, irrigation.

Mr. and Mrs. Roy Glenn, cattle feed, lot, etc.

George F. Brocke & Sons, Inc., cattle ranch. Used for irrigation, barn sanitation, etc.

There may be others of which we are unaware.

Also, the waters of the Potlatch river provide some fishing, water for grazing cattle in the area; water for wild animals and birds.

Taking that much from the Potlatch in a dry season would leave but two small trickles to keep the river going below the points of desired appropriation: Cedar Creek and Bear Creek. The other small streams could hardly be counted.

A Bit Of A Puzzle

Why apparently no publicity was given the "Notice to Appropriate" in any way until the required legal notice appeared and was detected by Mr. Hamilton is something of a mystery, and seems worthy of inquiry. It seems just a bit like California trying to get needed water from Idaho, while desperately saving their own!

It behooves everyone interested in the Potlatch River to "get on the ball" and protest the desired appropriation.

GOLDEN WEDDING OPEN HOUSE DEC. 3

Mr. and Mrs. Given Mustoe of Southwick will be guests of honor at an Open House in celebration of their 50th wedding anniversary on Sunday, Dec. 3, from 2:00 to 5:00 p. m., at the Southwick Ladies Aid Hall. Friends and relatives of the couple are invited to attend.

Mr. and Mrs. Mustoe were both born at Southwick, and have lived in that area continuously since 1932.

Their sons and daughters-in-law, Mr. and Mrs. Carl Mustoe of Page, and Mr. and Mrs. Jack Mustoe of Southwick will serve as hosts for the anniversary observance. A "pot of gold" will be presented to the honorees.

SOUTHWICK NEWS NOTES

MRS. ROLLIN ARMITAGE
Phone 289-4876

Golden Wedding Observance

The family of Mr. and Mrs. Given Mustoe is honoring them with an Open House this coming Sunday, between the hours of 2:00 and 5:00, at the Aid Hall in Southwick.

Club Christmas Dinner

Members of the Extension Homemakers Club will entertain their husbands at dinner this Saturday evening at 6:30, at the Rollin Armitage home. Bring a "fun gift" for the exchange.

Thanksgiving Gatherings

Mr. and Mrs. Clay King and Mr. and Mrs. Harve Triplett spent the day with Mrs. Iva May in Lewiston.

Mr. and Mrs. Aaron Wells and Mr. and Mrs. T. E. King and Sarah enjoyed dinner with Dr. and Mrs. Leonard Eldridge and family, Lewiston.

Mr. and Mrs. C. A. Cuddy entertained for Mr. and Mrs. Charles Cuddy and family of Orofino; Mr. and Mrs. David Cuddy and family and Mrs. Mabel Wimpey of Lewiston.

Mrs. Helen Cowger drove to Bovill to spend the day with her mother, Mrs. Cora Jennings. They were guests of Mr. and Mrs. Don Candler and family in that city.

Mr. and Mrs. David Gertje ate dinner with her parents, Mr. and Mrs. Ferd Puetz of Lewiston.

Mr. and Mrs. Given Mustoe and Mr. and Mrs. Jack Mustoe and Mark joined with other family members at the Otto Schoeffler home in Kingstons, Idaho.

The Verlin Benjamin family joined relatives at the Gertrude Pederson home in Juliaetta to celebrate the festive occasion.

Mr. and Mrs. John Lettenmaier had as guests Eddie Lettenmaier and Mr. and Mrs. Roger Brunella of Lewiston, and Mr. and Mrs. Duke Brunella of Clarkston.

Mr. and Mrs. Fred Lettenmaier enjoyed dinner with her brother-in-law and sister, Mr. and Mrs. Carl Strohm and family, Genesee.

T. J. Armitage was a dinner guest of Mr. and Mrs. Arlie Armitage, Nick and Tammy.

Mr. and Mrs. D. W. Tarry were host to Mr. and Mrs. Barney Driscoll, Mr. and Mrs. Charles Hill and Lester of Lewiston; Mr. and Mrs. Larry Neilson, Sharon Crow and Gary Moore, all of Clarkston, and Wm. Kauder.

Mr. and Mrs. James Whiting and daughters were dinner guests in the Gary Whiting home, Lewiston.

Mr. and Mrs. Henry Davis and Rowena entertained for Mrs. Etta Dygert, Virgil Dygert and Virgil, Jr., of Kendrick.

Mrs. Stella McIver was a guest at dinner in the Orville Choate home at Teakean.

Mr. and Mrs. Duane Meske and Mr. and Mrs. Rollin Armitage Grove to Nampa to enjoy Homecoming activities and events at Northwest Nazarene College. They stayed in the home of Mr. and Mrs. Dave Armitage from Thursday to Sunday.

Some of the highlights of the week-end were the Thanksgiving banquet Thursday afternoon; the college play, "Man for All The Seasons" that evening; a wild game dinner on Friday honoring the seniors of the year. That evening the Alumni vs. varsity basketball game. Duane participated in this event. The men also enjoyed some duck hunting between programmed events.

Other News

Mr. and Mrs. Elmer Browleit and daughters of Colfax were Wednesday over-night guests in the Verlin Benjamin home.

Mr. and Mrs. Herb Pederson and family of Ephrata were Friday over-night guests of Mr. and Mrs. Verlin Benjamin and family. Mr. and Mrs. Doug Pederson and Krysta of Connell joined these families, Saturday.

Mr. and Mrs. Larry Neilson of Clarkston visited from Thursday to Sunday in the D. W. Tarry home. Mr. and Mrs. Charles Hill of Lewiston joined them for Sunday dinner.

Saturday evening Ray Whiting visited his brother and family, Mr. and Mrs. James Whiting.

Mr. and Mrs. Otto Siffow of Juliaetta were Monday afternoon callers in the James Whiting home.

Last Tuesday Mr. and Mrs. Earl King of Seattle and Mr. and Mrs. T. E. King and Sarah visited Mr. and Mrs. John Stanley in Orofino, and were supper guests.

(Continued on Page 6)

CAMPER KARAVAN

The Kendrick Camper Karavan met Monday evening for a pot-luck dinner in the Kendrick Fire Hall, with 16 members present. Election of officers was held with Lloyd Craig being re-elected president; Cecil Gruell, vice president; Manning Onstott re-elected secretary-treasurer.

Mr. and Mrs. Cecil Gruell and Mr. and Mrs. Lloyd Craig were each presented a gift by the Karavan for attending the most camp-outs last summer.

A Christmas party was planned, with the date and place to be announced later by the entertainment committee.

LAVERNE KITE DIES OF HEART ATTACK

Clearfield, Utah — Laverne Hugh Kite, 42, of 256 W. 650th N., died Nov. 21 at the Hill Air Force Base Hospital of a heart attack.

Mr. Kite was born Oct. 11, 1925, in Moscow, Idaho, a son of John A. and Effie Hammond Kite. He lived at Kendrick for several years while he was a small child. He lived at Hooper, Utah, for 12 years, and the past four years in Clearfield.

He had been an aircraft mechanic at Hill Air Force Base for 20 years. On Nov. 9, 1943, he was married to Florence Lamoreaux in Provo, Utah.

He had been active in sports in the Hooper 1st LDS Ward and Clearfield 8th Ward. He had been vice president of the Weber County Babe Ruth League for four years, and District Director of the League for Northern Utah. He had worked in the Clearfield Recreation Department in baseball and basketball.

Surviving are his widow, and the following sons and daughters: Gary Lee Kite, serving with the Army at Ft. Knox, Ky.; David Ray Kite, serving with the Army in Vietnam; Allan J. Kite, Jackie Duane Kite, Richard John Kite, Delores A. Kite, all of Clearfield; Mrs. Robert Walker, Clinton, Utah. He also survived by three grandchildren, his mother of New Plymouth, Idaho; one brother and one sister, John L. Kite, Emmett, Idaho; Mrs. Mildred Steyl of Bellflower, Calif.; and one foster brother, Delbert Turner, Pomeroy, Wash.

Funeral services were held Nov. 25 at the Lindquist & Sons Mortuary.

LITTLE NANCY COOK, WINS BABY CONTEST

Nancy Cook, 11-month-old daughter of Mr. and Mrs. Asa Cook, Jr., Juliaetta, won the Kendetta Junior Women's Club baby contest in Saturday's ballot count.

Sixteen babies were entered with the winner determined by the residents of the Kendrick-Juliaetta area. Nancy won a \$25 U. S. Savings bond, two steak dinners for her parents, an electric food mixer, and a gift certificate for food as her prize.

Winners were announced through fifth place. They were: Melissa Groseclose, second, daughter of Mr. and Mrs. Larry Groseclose, Southwick; third, Mark Harris, son of Mr. and Mrs. Douglas Harris, Kendrick; fourth, twins Don and Dale Galloway, sons of Mr. and Mrs. Eddie Galloway, Jr., Kendrick; and fifth, Jeanette Nye, daughter of Mr. and Mrs. Lloyd Nye, Juliaetta.

The Kendetta Club will hold a coffee hour for the mothers of all entrants on Saturday, Dec. 2, at 3:30 p. m. in the Fire Hall. All entrants will receive a gift, and the winners awards will be made at that time. There will also be a picture taking session, so please bring your baby.

ANNUAL FAMILY DINNER THURSDAY

Seventy-two gathered for an annual family Thanksgiving dinner at the Kendrick Fire Hall on Thanksgiving Day, Thursday. Those present were:

Mr. and Mrs. Melvin Garner and Mr. and Mrs. George Garner and son, Elk City; Mr. and Mrs. Marvin Garner and family, Grangeville; Mr. and Mrs. Archie Garner and family, Ashton, Ida.; Mr. and Mrs. Gordon Garner and family and Mr. and Mrs. Lindsey Hayes, Coeur d'Alene; Mr. and Mrs. Wm. Brown and family of Wilbur, Ore.; Mr. and Mrs. Robert Lyons and sons, and Arthur Bohn, Lewiston; Mr. and Mrs. Lewis Porter, Mrs. Maude Pippenger, Mr. and Mrs. Wayne Pippenger and son, Mr. and Mrs. Paul Pippenger and son and Mr. and Mrs. Edgar Bohn, all of Orofino; Miss Carolyn Burns, Spokane; Mr. and Mrs. Arley Allen and Mrs. Ada Schoeffler, Juliaetta; Mr. and Mrs. Marion Souders and family, Mr. and Mrs. Elmer Cuddy and family, Miss Eileen Holt and Mr. and Mrs. Fred Foster and daughters, all of Southwick; Mr. and Mrs. Clarence Alexander and sons, Mr. and Mrs. Gene Foster and son and Mr. and Mrs. Arthur Foster, all of Kendrick.

Eight different groups of four generations were present.

The University of Idaho granted 1,190 degrees in 1966. In 1955, 611 degrees were granted.

LOCAL HAPPENINGS IN CAPSULE FORM

Mrs. Elmo Eldridge left Sunday to help care for their new grandson, Jeffrey Erin Eldridge, at Marysville, Wn. She expects to be away a week.

Mr. and Mrs. Fred Stedman left on Wednesday of last week to spend Thanksgiving with their son-in-law and daughter, Mr. and Mrs. Jeff Comyn and family at Seattle.

Thanksgiving Day guests of Mrs. Anna Long were Dr. Elbert Long of Hermosilla, Son, Mexico; Mr. and Mrs. Maurice Long and daughters of Opportunity, Wn.; Tom Long and daughters of Clarkston and Mr. and Mrs. Jim Odberg of Genesee.

Mr. and Mrs. Gordon Cook and children of Olympia, Wn., were visitors from Wednesday evening to Sunday in the home of his parents, Mr. and Mrs. Ben P. Cook. They also spent some time with her father, Joe J. Fox in Lewiston.

Fred Darby of Moscow was a Thanksgiving Day guest of his brother and sister, John and Elsie Darby.

Mr. and Mrs. Harry Dorendorf and family of Kellogg, and Kathy Dorendorf and John Farrington of the U. of I., were guests over the Thanksgiving holidays of Mr. and Mrs. Lloyd Farrington.

Mr. and Mrs. Roy Glenn entertained on Thanksgiving for Mr. and Mrs. Charles Easterbrook and family of Grangeville; Mr. and Mrs. Gary Browning and family, Mr. and Mrs. Charles Taylor and family and Paul Richardson, all of Juliaetta; Miss Ida Glenn of the U. of I., and Mr. and Mrs. Warney May, Jr., and sons.

Mr. and Mrs. Paul Lind were Thanksgiving guests of Mr. and Mrs. Leon Lind of Moscow. Mrs. Ida Lind, now of Paradise Manor, Moscow, was also present.

Mr. and Mrs. Dick Lind and John Lind of Moscow were Saturday visitors in the Paul Lind home.

Mr. and Mrs. W. L. McCreary and Kim Trout were Thanksgiving guests of Mr. and Mrs. Fred Richard in Lewiston.

Tom Cuddy, a North Idaho Junior College student, and Bill Cuddy and family, Jennifer Lynn and Robert, all of Thompson Falls, Mont., spent the Thanksgiving holidays with relatives in this area. All returned to their respective homes on Sunday.

Mr. and Mrs. Oral Craig and Neal Craig joined 31 Robeson family members at an annual Thanksgiving dinner in the Robeson brothers home at Lewiston Orchards, on Thursday.

Mr. and Mrs. Bill Brown and family of Wilbur, Ore., are visiting in the home of her parents, Mr. and Mrs. Arthur Foster. All were Saturday dinner guests of Mr. and Mrs. Fred Foster.

Saturday callers in the Oral Craig home, honoring Mr. Craig on his birthday anniversary, were Charles Craig and Mr. and Mrs. Ronald Craig and family, all of Lewiston; Mrs. Jerry Heistutmann and family of Moscow; Mr. Bill Weyen, Mrs. Wayne Harris and children and Lloyd Craig.

Mr. and Mrs. Everett Fey and son Dan and Chris Lyons joined family members at the Perry Mattoon home at Troy for Thanksgiving.

(Continued on Page 2)

CUB SCOUTS BUSY

Den 5 of Pack 114, Cub Scouts, met in the Fire Hall on Nov. 7th. They made rope quilts, part of a Scout Achievement.

On Nov. 14th the Den visited the Depot, and Mr. Wallace told the boys about rail transportation. The Cubs also collected leaves.

Nov. 21st the Cubs met and made Thanksgiving centerpieces and neckerchief slides.

Nov. 27th the following Awards were given: Kevin Renfrow, a Silver Arrow on Bear Rank, a Lion badge and Gold Arrow on Lion. Ray Clayton received a Gold and Silver Arrow on the Wolf rank; Doug Christensen, Silver Arrow on Bear Rank, Lion badge, Gold and Silver Arrow on Lion rank. Lee Doobald received a one-year pin. Kevin Renfrow a two-year pin and an Attendance bar. Montie Price has become a member of Den 5.

TO SELL LICENSES

Eugene Taylor, County Assessor, announces that licenses for cars, pickups, light trucks, etc., will be available in Kendrick on Saturday, Dec. 2nd, at the Brocke & Sons, Inc., TV store, between the hours of 9:00 a. m. and 5:00 p. m. Be sure and bring either your registration or certificate of title.

91 YEARS YOUNG

Mrs. N. H. Stedman was honor guest at a combined birthday and pre-Thanksgiving dinner at the home of their son and daughter-in-law, Mr. and Mrs. Fred Stedman, on Sunday, Nov. 19. Other guests were Mr. and Mrs. Samuel Stedman and family of Clarkston.

OUT OF HOSPITAL

Mrs. John Thomas of Deary returned home Nov. 22 from the Moscow hospital following a gallstone operation. She is gaining strength slowly.

BIG BEAR RIDGE BY HAPPY HOME CLUB

Annual Meeting

The Big Bear Ridge Community Club will hold its annual meeting on Monday evening, Dec. 4, 7:30 p. m. at the hall. All members are welcome. Please remember the date.

Club Holds Meeting

The Happy Home Extension Club met at the Community Hall, Tuesday afternoon. Election of officers was held. It was voted to retain the present officers for another year: President, Hulda Clemenhagen; Vice President, Elsie Chamberlain; Secretary, Grace Ingle; Treasurer, Elma Hazeltine. It was decided for each to bring a gift for the State Hospital North, instead of having a gift exchange at our annual family Christmas dinner and party.

A discussion was held on the Gold Bond Stamp project. Elsie Chamberlain was appointed to "get the ball rolling."

Miss Nancy Palmer, extension agent, Moscow, gave the lesson on "Hazards of Household Chemicals" which was enjoyed by 20 members and four children. Pie and coffee and cider was served at the close of the meeting.

Card Party Success

A good time was reported at the card party Saturday evening at the Community Hall. High scores went to Mr. and Mrs. Robert Clemenhagen; lows to Mrs. Glen Stevens and Cecil Dean. Roy Clemenhagen took home the "goose."

Stamp Book Covers Needed

The Happy Home Club would appreciate receiving trading stamp book covers from all of your stamp books when you redeem them.

Thanksgiving Doing

The Misses Nancy Holsington of Patricia Stevens Career College, Salt Lake City, Utah, and Linda Marie of the U. of I., spent Thanksgiving vacation in the home of their parents, Mr. and Mrs. Lauren Holsington and family.

Miss Laurine Hazeltine of Lewis-Clark Normal spent the vacation with her parents, Mr. and Mrs. Pearl Hazeltine and Darold.

Mr. and Mrs. Oscar Slind spent Thursday and Friday at Spokane with her mother, Mrs. Wm. Leland and other relatives. They joined other family members for Thanksgiving dinner in the lovely new home of her brother-in-law and sister, Mr. and Mrs. George Moline, Spokane.

There will be a Candy Making workshop at the Community Hall on Thursday, Dec. 7th, starting at 10 a. m. Bring your recipe and a sack lunch. Everyone welcome.

Dr. and Mrs. Roger Jones and daughters of Tacoma spent Thanksgiving here with his mother, Mrs. Janice Jones.

Thanksgiving dinner guests in the Ray Jones home were Mr. and Mrs. Stanton Bennett and daughters of Spokane; Mr. and Mrs. Ray Shoemaker and Mr. and Mrs. Francis Havlina of Connell, Wn.; Dr. and Mrs. Roger Jones and daughters of Tacoma; Mrs. Iva Jones, Moscow, and Mrs. Janice Jones.

Ed. Halseth and sons Gerald and Arnold were Thanksgiving dinner guests of Mr. and Mrs. Ben Chisholm and family, Lewiston.

Mrs. Bertha Lillie of Lapwai and Mrs. Richard Witt were Thanksgiving dinner guests of Mr. and Mrs. Ervin Halseth and Pam.

Thanksgiving guests of Mr. and Mrs. Eddie Galloway were Mrs. Anna Bower, John, Andy and Dewey Galloway, Clarence Morey, Mr. and Mrs. Harold Larson of Leland and Mr. and Mrs. Ed. Galloway, Juliaetta.

Mr. and Mrs. Pearl Hazeltine and family were Thanksgiving guests of her parents, Mr. and Mrs. Arthur McMillan, at Asotin.

Mr. and Mrs. Cecil Chamberlain were Thanksgiving Day guests of Mr. and Mrs. Harley Perryman and Gene, on Cedar ridge.

Mr. and Mrs. Chas. Bower joined relatives for Thanksgiving dinner at the home of Mr. and Mrs. Harry Schwartz and daughters, Troy.

Leroy Cooke and Giles Chittenden of Auburn, Calif., visited Mrs. Anna Bower Monday afternoon. The men left for their homes Tuesday morning after spending two weeks hunting in this area.

James Huffman of Grants Pass, Ore., spent Tuesday and Wednesday in the home of Mr. and Mrs. Henry Galloway. Other guests for dinner Tuesday were Mr. and Mrs. Larry Galloway and family, Lewiston, and Mr. and Mrs. Harold Larson, Leland.

Mr. and Mrs. Henry Galloway took James Huffman to the Larry Galloway home in Lewiston Wednesday evening, where he will visit.

Thanksgiving guests of Mr. and Mrs. Henry Galloway were Mr. and Mrs. Larry Galloway and children and Clarence Huffman.

Mr. and Mrs. Grant Clemenhagen accompanied Mrs. Ida Ruby and Betty Jean and Clifford Swanson to St. Maries, where they were Thanksgiving guests of Mr. and Mrs. Geo. Collage and family.

Mr. and Mrs. Jerry J. Ingle and family joined relatives in the home of Mr. and Mrs. Don Nelson and sons at Deary for Thanksgiving. In the evening they called on the Cecil Dean family, Deary.

LaVerne Dalberg and son of Lewiston were Sunday visitors of Mr. and Mrs. Oscar Slind.

Relatives have received cards from the Holy Land and East Jerusalem, where Mrs. Otto Alber of Dinuba, Calif., is enjoying a tour with a church group.

Sunday dinner guests of Mr. and Mrs. Ervin Halseth and family were Ed, Arnold, Gerald and Harold Halseth, the latter of Seattle, and Mr. and Mrs. Boyd Leland and daughters of Clarkston.

Mr. and Mrs. Cecil Dean and sons of Deary were Sunday guests in the parental home, Mr. and Mrs. A. M. Blanford.

Miss Leona Wilson of Union City, Calif., and Don Fawkes of Alameda, Calif., arrived Thanksgiving morning at the home of her parents, Mr. and Mrs. A. C. Wilson, for the holi-

days. Others enjoying Thanksgiving dinner there were Mr. and Mrs. Emmett Martin and sons of Lewiston; Mr. and Mrs. Jay Dee Wilson and Eldon. Mrs. Pat Thompson and daughter Rhonda of Clarkston arrived in the evening to spend the week-end. Miss Wilson and Mr. Fawkes, left Saturday noon for their California homes.

Sunday dinner guests of Mr. and Mrs. A. C. Wilson and Wayne were Mr. and Mrs. Wm. Adams and Connie of Orofino; Mr. and Mrs. Manly Waldron and children, Bovill; Mr. and Mrs. J. D. Wilson and Eldon; Mrs. Vern Whitlock and children of Lewiston; Mrs. Thecla Knopes, Mrs. Frances Hadley, Mrs. Pat Thompson and Rhonda, all of Clarkston.

Latest report from Mrs. Claribel Anderson is that she is getting along very satisfactorily, and recuperating in a rest home. For those who might care to write her address is: Care of Cloister Felipe Rest Home, 3737 Don Feleta Drive, Los Angeles, Calif., 90045.

Mr. and Mrs. William Ingle of Hubbard, Ore., arrived Thanksgiving morning for a visit with his mother, Mrs. Linnie Ingle and other relatives. They left for home, Saturday.

Mrs. Linnie Ingle, Mr. and Mrs. Gerald Ingle and Mr. and Mrs. Wm. Ingle, Hubbard, Ore., were dinner guests Thanksgiving of Mr. and Mrs. A. A. Kremmin, Juliaetta.

Visitors in the J. D. Wilson home Friday afternoon were John Thomas of Deary, and Gary Pierce, Spokane.

Thanksgiving dinner guests of Mrs. Helen Hinrichs and Herman were Ray Jones and son Randy of Lewiston, and Mr. and Mrs. Alex Larson.

Mr. and Mrs. Alex Larson were Sunday afternoon visitors of Mr. and Mrs. Frank Van Hise.

Eldon Wilson spent Tuesday afternoon with Keith Ingle.

Thanksgiving dinner guests of Mr. and Mrs. Joe Clemenhagen were Mr. and Mrs. Alvin Mathison and Mr. and Mrs. Mahlon Mathison and children, all of Lewiston; Mr. and Mrs. Max Clemenhagen and children and Roy Clemenhagen.

Word has been received of the death of Mrs. Milton Carnefix of Koooskia. She will be remembered as Margaret McBride, an early-day resident of this ridge.

Mr. and Mrs. Pearl Hazeltine and family attended the Golden Wedding Anniversary Open House of her uncle and aunt, Mr. and Mrs. Wesley McMillan of Asotin county, at the Y. W. C. A. in Lewiston, Sunday.

Mrs. Gertrude Heffel of Orofino spent Friday and Saturday with Mr. and Mrs. Eddie Galloway and sons.

Mr. and Mrs. Marvin Vincent returned Wednesday evening from a two-week vacation trip to Portland — and on to Hawaii by plane.

Thanksgiving Mr. and Mrs. Marvin Vincent were Clarkston visitors, to meet their new great-grandson, Clinton Walker, son of Mr. and Mrs. Dick Walker (nee Carol Vincent), born while they were in Hawaii.

Mr. and Mrs. Andy Dreps were Sunday dinner guests of Mr. and Mrs. Herman Johnson. Walter Cook was a Monday visitor.

Mrs. Herman Johnson and Mrs. Robert Draper attended a bridal shower honoring Miss Ann Yenni at Teakean, Friday evening.

Mrs. Charles Hoffman is staying in Lewiston with Mrs. Esther Winegardner, to be near Charles Hoffman, a patient at St. Joseph's Hospital.

Thanksgiving Time Doings
Mr. and Mrs. Walter Crawford were Wednesday over-night and Thanksgiving dinner guests of Mr. and Mrs. Kevin Crawford at St. Maries.

Mr. and Mrs. Gordon Peters were among the Thanksgiving dinner guests of Mrs. Sylvia O. Peters at Clarkston.

Mr. and Mrs. Wayne Harris and family of Kendrick; Mr. and Mrs. Gerry Heitstumann and family of Moscow and W. H. Weyen were dinner guests of Mr. and Mrs. Bill Weyen and Debbie, Thanksgiving Day.

Mr. and Mrs. Homer Parks and Mr. and Mrs. Luther Parks and family were Thanksgiving dinner guests of Mr. and Mrs. Bud Roach and family at Kamiah. Dean Roach came home with Mr. and Mrs. Homer Parks to spend the week-end.

Mr. and Mrs. Jesse Thornton were Thanksgiving dinner guests of Mr. and Mrs. Willis Thornton and family and over-night nights of Mr. and Mrs. Ray Thornton and family, Lewiston. On Friday they accompanied them to Boise where all visited until Sunday with Mr. and Mrs. Boyd Thornton and family.

Mr. and Mrs. Ervin Draper and family were among the Thanksgiving dinner guests of Mr. and Mrs. Ed. Campbell and family, Lewiston.

Mr. and Mrs. Roy Craig were dinner guests Thanksgiving of Mr. and Mrs. George Baugh, Orofino.

Thanksgiving dinner guests of Mr. and Mrs. Lloyd Craig and Jean were Mr. and Mrs. Virgil Flesham of Clarkston; Cecil Flesham, Camas, Wn., and Mr. and Mrs. Wesley Pike and family, Lewiston.

Mr. and Mrs. W. A. Deobald and family, Moscow, were Thanksgiving evening dinner guests of Mr. and Mrs. Robert Draper. Mr. and Mrs. Ervin Draper were also evening visitors.

Mr. and Mrs. Bill Thornton and Mr. and Mrs. Jim Thornton and family were dinner guests Thanksgiving of Mr. and Mrs. Rudy Meyer and family in Juliaetta.

Mr. and Mrs. Herman Johnson and Mr. and Mrs. Frank Hunt were the Thanksgiving dinner guests of Mr. and Mrs. Andy Dreps, Lewiston.

Mr. and Mrs. Gerald Schmidt and family, David Wilson and Mrs. Chas. Schultz were Thanksgiving dinner guests of Mr. and Mrs. Bill Thornton and son.

Thanksgiving dinner guests of Mr. and Mrs. Henry Bell were Mr. and Mrs. Fred Heinje and Linda of Lenore; Mr. and Mrs. Reinhard Wilken and Mr. and Mrs. John Blair.

Mr. and Mrs. Hugh Malone and daughter Phyllis and Mr. and Mrs. Lou Vesquez were week-end guests of Mrs. Elsie Hoffman, and all were Thanksgiving dinner guests of Mr. and Mrs. Howard Hoffman and family in Kendrick.

Mr. and Mrs. Harold Silflow, Ernest Heimgartner and Mr. and Mrs. Herbert Schwarz and family were dinner guests Thanksgiving of Mr. and Mrs. Ernie Heimgartner, Clark-

ton. Mr. and Mrs. Fred Silflow, Juliaetta; Mr. and Mrs. Virgil Felton and family, Lewiston; Mrs. Dorothy Hereth, Gary and Freddie Silflow were Thanksgiving dinner guests of Mr. and Mrs. Emil Silflow and family.

Mr. and Mrs. Howard Wolff and family, Mr. and Mrs. Walter Wolff and family, Mrs. Alfred Nelson, Mr. and Mrs. Walter Nelson and Bruce, the latter of Garfield, were dinner guests Thanksgiving of Mr. and Mrs. Leonard Wolff.

Mr. and Mrs. Harold Bartlett and Terry, and Charles Fey were Thanksgiving guests of Mr. and Mrs. Ted Fey and family.

Denise Wolff was a Monday over-night guest of Helen Fey.

Mrs. Howard Wolff and sons and Mrs. Leonard Wolff visited Sunday afternoon with Scott Lohman.

Other News
Mrs. Wesley Pike and family were week-end guests of Mr. and Mrs. Lloyd Craig and Jean. Mr. and Mrs. Roy Craig were Sunday visitors.

Mrs. Bud Roach and son Mark of Kamiah were Friday and Saturday visitors of Mr. and Mrs. Homer Parks.

Mr. and Mrs. Jesse Thornton were Tuesday morning visitors of Mr. and Mrs. Oral Craig, Kendrick.

Mrs. Gerry Heitstumann and family of Moscow spent the past week with Mrs. Bill Weyen, while the men were on a hunting trip.

Mr. and Mrs. Jesse Thornton and John Vincent were Monday visitors of Mr. and Mrs. Robert Draper.

A week ago Sunday Mr. and Mrs. Wayne Tower of Dawson Creek, B. C.; Mrs. Lawrence Heimgartner, Mrs. C.; Mrs. Lawrence Heimgartner, Mrs. Richard Groseclose, Mr. and Mrs. David Johnson and family, Mr. and Mrs. Art Fraser, Kathy and David of Lewiston; Mr. and Mrs. Bud Fey, Charles Fey and Debbie Johnson were dinner guests of Mr. and Mrs. Ted Fey and family.

Tami, Debbie, Mike and Cheryl Hutton, Juliaetta, were Friday and Saturday guests of their grandparents, Mr. and Mrs. Gordon Peters.

Mr. and Mrs. Leonard Wolff were Sunday evening guests of Mr. and Mrs. Reinhard Wilken.

Mr. and Mrs. Robert Thorne and sons of Tacoma were Saturday callers of Mr. and Mrs. Herman Johnson.

Lyle Parks, Blackfoot, was a Wednesday visitor of Mr. and Mrs. Homer Parks.

Ernest Heimgartner was a Monday visitor of Mr. and Mrs. Harold Silflow.

Mr. and Mrs. Bob Henriksen and family, Troy; Mrs. Lloyd Nye and family and Bill Johnson were Sunday dinner guests of Mr. and Mrs. Gordon Peters.

Mr. and Mrs. Manning Onstott and Mr. and Mrs. Art Foster were Sunday evening visitors of Mr. and Mrs. Lloyd Craig.

Mr. and Mrs. Marvin Vincent returned Wednesday evening from a two-week vacation trip to Portland — and on to Hawaii by plane.

Thanksgiving Mr. and Mrs. Marvin Vincent were Clarkston visitors, to meet their new great-grandson, Clinton Walker, son of Mr. and Mrs. Dick Walker (nee Carol Vincent), born while they were in Hawaii.

Mr. and Mrs. Andy Dreps were Sunday dinner guests of Mr. and Mrs. Herman Johnson. Walter Cook was a Monday visitor.

Mrs. Herman Johnson and Mrs. Robert Draper attended a bridal shower honoring Miss Ann Yenni at Teakean, Friday evening.

Mrs. Charles Hoffman is staying in Lewiston with Mrs. Esther Winegardner, to be near Charles Hoffman, a patient at St. Joseph's Hospital.

MORE PERSONALS

(Continued from page 1)

Thanksgiving dinner guests of Mr. and Mrs. Robert Watts and Patti were Mr. and Mrs. Joe Watts and daughters of Moscow, and Mrs. W. A. Watts. Mr. and Mrs. H. M. Barber of Coeur d'Alene were week-end guests.

Dinner guests Thanksgiving of Mr. and Mrs. Herman Schupfer were Mrs. Norris Walker of Clarkston, and Mr. and Mrs. Bud Eichner and family. Mrs. Walker remained over the holidays.

Mr. and Mrs. A. O. Kanikkeberg and Mr. and Mrs. Burton Souders, Jr., and family were dinner guests on Thanksgiving Day of Mr. and Mrs. Ozzie Kanikkeberg and family at Genesee.

Mr. and Mrs. R. L. Blewett were dinner guests on Thanksgiving Day in the home of their son and daughter-in-law, Mr. and Mrs. Bill Blewett at Lewiston.

Mr. and Mrs. Arnie Zumhove were Thanksgiving dinner guests at the Walter Zumhove home. Bobby and Jimmy Bain, Moscow, were Thanksgiving holiday visitors in the Ben Westendahl home.

Dana Magnuson, student at Pomona College, Claremont, Calif., arrived home on Wednesday of last week to spend the Thanksgiving holidays with his parents, Mr. and Mrs. Bob Magnuson, and with the Dick Morton family at Newport, Wn. The Magnusons returned home on Saturday evening.

Dr. Elbert Long of Hermosillo, Son, Mexico, was a house guest of Mr. and Mrs. Marvin Long from Wednesday until Monday, when he returned to his home by plane. While here he visited other relatives.

On Friday, Mr. and Mrs. Roy Long and son and Mr. and Mrs. J. E. Key, all of Spokane, and Mrs. Pearlie Long were also dinner guests.

Mr. and Mrs. Frank Faulker of Pullman were Monday guests of Mr. and Mrs. Marvin Long.

Mr. and Mrs. Roy Long and son William of Spokane were guests from Wednesday through Sunday of his mother, Mrs. Pearlie Long. Those joining them on Sunday for a no-host dinner were Mr. and Mrs. J. E. Key of Spokane; Mr. and Mrs. Jim Odberg of Genesee; Dr. Elbert Long of Hermosillo, Son, Mexico; Mrs. Anna Long and Mr. and Mrs. Marvin Long. The two latter were also Thanksgiving guests of Mrs. Pearlie Long.

Mr. and Mrs. John Wilson were Saturday and Sunday guests of Mr. and Mrs. Ray Jordan and daughters at Spokane. Mrs. Ada Cain accompanied them and visited at the home

of Mr. and Mrs. Bruce Kidder at Jummer.

Mr. and Mrs. Theodore A. Deobald and family of Richland, Wn., spent the Thanksgiving school holidays in the home of their parents, Mr. and Mrs. E. A. Deobald and Mr. and Mrs. E. M. White.

Thanksgiving dinner guests of Mr. and Mrs. George Brocke, Sr., were Mr. and Mrs. Robert Clemenhagen, and Don, Vicki and Cindy Brocke.

Mr. and Mrs. Harvey Dale and family of Lewiston; Mr. and Mrs. Keith Thornton and family of Peck, and Mr. and Mrs. T. A. Deobald and family of Richland were Thanksgiving evening dinner guests of the women's parents, Mr. and Mrs. E. M. White.

Mr. and Mrs. Dave Clayton and sons were Thanksgiving day guests of her parents, Mr. and Mrs. C. J. Perry and daughter Bea of Grangeville.

Mr. and Mrs. Jack Delaney and sons of Orofino; Mrs. H. F. McCollister of Lewiston, and Mr. and Mrs. Ray Onstott and son of Deary were Thanksgiving dinner guests of Mr. and Mrs. Manning Onstott.

Ted Turner of Whitworth College, Spokane, spent the Thanksgiving school holiday at the home of his parents, Mr. and Mrs. Wm. Turner.

Mr. and Mrs. Cecil Choate, Mr. and Mrs. Vern Choate and Mrs. Marguerite Silflow joined Mrs. Nova Pearson and Fred Goslin for Thanksgiving dinner at a Lewiston restaurant on Thursday.

Larry Helton of Portland; Miss Bernice Davey of Kelso, Wn.; Marilyn and Carolyn Helton of Lewiston were Wednesday over-night guests of Mr. and Mrs. Ward Helton. All were Thanksgiving dinner guests of Mr. and Mrs. Henry Freytag at Helmer.

Mr. and Mrs. George Brocke, Jr., and son Dean and Miss Lynda Fey were Thanksgiving guests of relatives at Kellogg. Mr. and Mrs. Gerald Harris and family of Orofino were guests on Sunday in the Brocke home.

Mr. and Mrs. Lester Wallace were Thanksgiving dinner guests of Mrs. John Theissen of Clarkston. Mr. and Mrs. Randy Wallace and children of Lewiston were Sunday guests.

Fred Silflow of Juliaetta was a recent visitor in the Aug. F. Wegner home.

Mr. and Mrs. W. A. Deobald and family of Moscow were Wednesday over-night guests of his mother, Mrs. Elsie Deobald. Mrs. Deobald was a Thanksgiving dinner guest of Mr. and Mrs. Allen Sather at Genesee.

Mr. and Mrs. Jack Mathoney, parents of Mrs. James Hoogland, returned to their home near Twin Falls on Saturday, following a ten-day visit in the Hoogland home. Other Thanksgiving guests were her sister, Mrs. James Bevis, also of southern Idaho, and Mr. Hoogland's parents, Mr. and Mrs. James Hoogland, Sr., of Grangeville.

Mr. and Mrs. Doug Christensen entertained their parents, Dr. and Mrs. D. A. Christensen, and Mr. and Mrs. C. J. Horting, the latter of Colfax, at Thanksgiving Day dinner.

Mr. and Mrs. Ed. Nelson, Mr. and Mrs. Roger Nelson of Moscow, and Mrs. Elsie Wegner, Pullman, were Thanksgiving guests of Mr. and Mrs. Harry Wegner at Pullman.

Mr. and Mrs. Roger Nelson, Moscow, visited Sunday evening in the Ed. Nelson home.

Monday Mrs. Henry Wendt and Mr. and Mrs. Ed. Nelson visited with Mrs. Elsie Wegner at Pullman.

Thanksgiving guests of Mr. and Mrs. Ed. Brown were the Ken Wohlhab family of Auburn, Wn., who remained through the holidays; Mrs. Don Jensen and daughters of Moscow; Debbie Cope, Juliaetta; the Don and Kenneth Brown families. The Milford Osburn family and Dan Saiter were evening callers.

Mrs. Shirley Wade of Princeton and family were Thanksgiving dinner guests of Mr. and Mrs. Milford Osburn and family. The Osburns returned the visit on Sunday.

Mr. and Mrs. Harold Olderness returned home on Friday from Seattle. She had attended "Spring Market" week there. He went to the coast on Wednesday and there joined family members for Thanksgiving dinner.

Thanksgiving guests of Mr. and Mrs. Walter Brocke were Mr. and Mrs. Everett Crocker and Mrs. Millie York of Lewiston; Mr. and Mrs. Neil Wagner of Walla Walla, and Mr. and Mrs. Frank Abrams, Lewiston, were evening luncheon guests.

Thanksgiving dinner guests of Mrs. Eula Miller were Mr. and Mrs. W. D. Miller, Lewiston, and three of her aunts, from Clarkston; Mr. and Mrs. Lester Crocker, Pat and Debbie Johnson.

Guests of Mr. and Mrs. Carl Gustafson were Mr. and Mrs. Jack Newcomer and family of Sedro Wooley, Wn.; Mr. and Mrs. Robert Fraser and son of Calder, Ida.; Mr. and Mrs. Ben Levellie and son, Clarkston.

Mr. and Mrs. Roland Little spent Thanksgiving with their son-in-law and daughter, Mr. and Mrs. Gunther Hertling, and family at Seattle. They returned home on Saturday.

JOBS ARE DOWN

Moscow — Job opportunities in the Moscow area dropped this week from what the Moscow Department of Employment had received during the previous week, according to a report by Frank J. Hartstein, manager. Seventeen jobs were received during the current week, while one week ago 29 jobs were received. Job placements were greatly reduced also.

The nine people placed on jobs by that office during the past week corresponded with 20 the week before and 13 one year ago. There were 48 jobs still available at that office.

WILDLIFE MEETING

The Wildlife Federation will hold a public meeting, Tuesday, Dec. 5 at 7:30 p. m. in the Kendrick Fire Hall. The session will also be a district meeting.

Art Manley will be the guest speaker. There will be a film "Last Frontier."

Refreshments will be served.

KENDRICK WELDING & MACHINE SHOP
VIRGIL DYGERT
Wrecker Service Blacksmithing
Hard Surfacing
Phones: Shop 289-4177 Residence 289-4173

BROWER-WANN MEMORIAL
Kermit Malcom, Manager
Simple, dignified funeral services.
New building, pleasant surroundings
PHONE SH 3-4578 LEWISTON, IDAHO

For low cost results — use a Gazette Want Ad.

NOTICE
WE WILL BE CLOSED
ON
SATURDAYS 'TILL FURTHER NOTICE
KENDRICK ROCHDALE COMPANY
KENDRICK, IDAHO PHONE 289-4961

WE DELIVER
MOBIL OIL MOBIL GAS
MOBIL HEAT 100
MOBIL FUEL DIESEL
MOBIL LUBRICANTS
(Of All Kinds)
We Will Order Any Special Items Desired
MOBIL TIRES - BATTERIES
We Give S & H Green Stamps on All Burning Oil —
if paid by the 15th of month following
M. F. HEDLER
Representing The
MOBIL OIL COMPANY
KENDRICK, IDAHO
Phone 289-4061 Residence 276-3131

Frozen Foods of All Kinds — Blewett's Grocery

**INCOME TAX TIME COMING AND
YOU'RE JUST A LITE WORRIED**
About How Complete Your Records
May Be?

**AT LEAST —
YOU'VE GOT THE KEY TO THE
SITUATION**
When You Carry Checking and Savings
Accounts With Us!
Deposit Slips, Pass Books for Savings Accounts and Cancelled Checks tell the story!
**WHERE YOU ARE A CUSTOMER AND
FRIEND — NOT JUST A NUMBER**
FIRST BANK OF TROY
TROY, IDAHO
OFFICERS:
F. O. BROCKE, President MORRIS P. BOHMAN, V.-Pres.
PAT J. NUNAN, Cashier RAYMOND SODERSTROM, Asst. C.
DIRECTORS:
JOHN THEISSEN F. O. BROCKE W. A. BOHMAN
C. ARTHUR JOHNSON O. RONALD BOHMAN M. P. BOHMAN



HUNTERS MUST STOP

Boise — Hunters must stop at checking stations when enroute of travel. The same law applies to fishermen.

The Fish and Game department explains that the reason is not just part of a conservation enforcement procedure. Its purpose is to assure complete collection of game and fish management information. Much of this information is obtained directly from hunters and fishermen — and from examining game and fish — that cannot be learned in any other way.

This photo was taken a few weeks ago at the Marsing checking station.

LEAVES COME TUMBLING DOWN

The sharp cold of Saturday and Sunday nights — 20 and 19 respectively, have reduced the leaves on trees and brush to the point where hunters can begin to see a bit in the thickets, now that season is all but over.

Trees about town that had been holding onto their leaves, let go of them with a vengeance, and now the final clean-up of the fall will be possible, weather permitting.

The Potlatch River, which had shown a slight fall rise — dropped sharply, and ice covered the rocks along its banks, left there by the receding water.

Farmers say fall-sown wheat has not been hurt, and can take it unless

alternate freezing and thawing develops. However, most say some snow would be most welcome.

CEDAR RIDGE AND I N DEN
MRS. ROBERT PRATT
Phone 289-4698

Club To Meet

The Friendly Neighbor Club will hold an all-day meeting Wednesday, Dec. 6, at the Kendrick home of Mrs. Dick Parsley.

Other News

Thanksgiving Day dinner guests of Mr. and Mrs. Harley Perryman and Gene were Mr. and Mrs. Cecil Chamberlain of Big Bear ridge; Mrs. Eva Perryman and Clarence of Kendrick.

Mr. and Mrs. Jack Parsley and family were guests Thanksgiving Day of her grandmother, Mrs. Tony Piraino at Lewiston. Wednesday evening Mr. and Mrs. Dale Parsley and children, San Jose, Calif., and Mr. and Mrs. Dick Parsley were dinner guests in the Jack Parsley home.

Friday evening all the Parsley families were dinner guests of Mr. and Mrs. Jack Shepherd and family at Clarkston.

Mr. and Mrs. John Cuddy were Thanksgiving guests of Mr. and Mrs. Roger Christensen and family at Yakima.

Mr. and Mrs. Richard Schliefer and baby, Mrs. Amanda Schliefer

and Mr. and Mrs. Elmer Weaver and baby, all of Lewiston, were Thanksgiving dinner guests of Mr. and Mrs. Sam Weaver and Cheryl. Cheryl returned to Lewiston to stay overnight and Friday with the Schliefers. The Elmer Weavers and Kenneth Dennler brought Cheryl home Friday and spent the week-end.

Guests Thanksgiving Day and through this week of Mr. and Mrs. Roland Browning are her brothers and their wives, Mr. and Mrs. Hugh Cox of Elk Grove, Calif., and Mr. and Mrs. Woodrow Cox of Sacramento, Calif.

Steve Stoll, Burley, Ida., and Richard Patterson, Denville, N. J., U. of I. students, came home with Bob Pratt to spend the Thanksgiving holidays in the Robert Pratt home.

Mr. and Mrs. Lawrence Schliehuber, Deary, and Bruce Schliehuber, Lewiston, were Thanksgiving Day guests of Mr. and Mrs. Dan Kechter and family.

The Marion Souders family joined other relatives at the Kendrick Fire Hall, Thanksgiving Day for their annual family dinner.

Sharalyn Benfell, U. of I. student, arrived Wednesday evening to spend the Thanksgiving vacation with her grandmother, Mrs. Ida Lyons, and other relatives. Thursday Mrs. Lyons, Sharlyn and Clem Lyons drove to Spokane to spend Thanksgiving with Mr. and Mrs. Dan Lyons. Clem and Sharalyn returned home Friday, and Mrs. Lyons on Sunday.

Mrs. Jean Brammer, Clarkston, and Mr. and Mrs. Aug. Brammer, Cameron, were Thanksgiving Day guests

in the Cecil Brammer home. Mr. and Mrs. Ersel Hudson, Bobby, Doug and Jerry of Potlatch; Mr. and Mrs. Lloyd Kimbley of Kendrick; Mrs. George Magee and Bill of Lewiston; Mrs. Anna Baker, Russell Baker and Bob Kimbley were Thanksgiving Day guests in the Alva Craig home.

Mr. and Mrs. Charles Cuddy and children of Orofino were guests Thursday evening through Saturday. Bill Ball, Boise Jr. College; David Ball of the U. of I., and Gary Bail of Craigmont spent the holiday week-end in the Elmer Cuddy home. Miss Eileen Holt, Bill, David and Gary and Mr. and Mrs. Elmer Cuddy and Kelly attended the Thanksgiving Day dinner at the Kendrick Fire Hall.

Mr. and Mrs. Conrad Swan of Moscow were Thanksgiving Day dinner guests of Mr. and Mrs. Billy Wilson and Alvin.

Mr. and Mrs. Neil Grinolds and Jeff were Thanksgiving Day guests of Mr. and Mrs. Ted Grinolds and family in Clarkston. Mr. and Mrs. Teddy Grinolds and a friend came up Sunday. Darlene Chilberg joined them for the afternoon and evening.

Bill Cuddy and children, Thompson Falls, Mont.; Mr. and Mrs. Dick Cuddy, Kendrick, and the James Holt family enjoyed Thanksgiving dinner in the Ray Cuddy home. The Cuddy children stayed through Sunday to visit with relatives in the area.

Bill Cuddy, Pinehurst, was a Sunday over-night guest of Mr. and Mrs. Ray Cuddy. He has just recently returned from duty in Vietnam, and has been discharged.

Mr. and Mrs. Phil Bahr accompanied Mr. and Mrs. Bing Blanford of Big Bear ridge to Mohler, Wn., to spend Thanksgiving with Mr. and Mrs. Solly Miller. They returned home on Friday.

Ronnie Konen, Uniontown, was an over-night guest of Mr. and Mrs. Phil Bahr, Monday of this week.

Mr. and Mrs. Archie Garner and family of Ashton, Ida., were Friday over-night guests of Mr. and Mrs. Marion Souders and family. Mr. and Mrs. Elmer Cuddy were Friday evening callers.

Skip and Sandra Arnett, Kendrick, spent Saturday and Sunday with their grandparents, Mr. and Mrs. Phil Bahr.

WEATHER WILD, WET AND BIT CHILLY

Weather over the past week has had just a bit of everything in it — from rain squalls to high winds —

sunshine and more wind and rain.

Friday morning the wind really blew up a storm, and carried with it clouds of dust which, combined with the rain, plastered windows with another "mud" bath, but not nearly as bad as that of three weeks ago.

Mid-day temperatures have been in the upper 40's, with lows at night in the mid 30's, with lots of cloudiness. The air has been so full of moisture most of the time that the temperature feels lower than it really is.

Saturday morning, after a chill and windy night, the first snow of the season arrived, a snow that melted as fast as it hit here in the canyon, but left up to an inch on some of the ridges.

Saturday night was clear and cold, the thermometer recording 20 degrees.

Sunday was a sunny one, but cold, and that night the reading hit 19 above.

Monday was a raw, chill day, with the thermometer barely getting above the freezing mark.

HOMEMAKING TESTS DEC. 5TH

Senior class girls in the high school here will be among more than a half million others in approximately 10,000 high schools across the country who will participate Tuesday, Dec. 5 in a written knowledge and attitude test touching on all phases of homemaking.

One of the girls will go on to merit a \$5,000 college scholarship as All-American Homemaker of Tomorrow. National runners-up will be granted \$4,000, \$3,000 and \$2,000 in scholarships, respectively. State winners will be awarded \$1,500 scholarships with state runners-up receiving \$500 grants. Winners in each local high school will be presented specially designed silver charms and will have their test papers entered in state competition.

BIDS OPENED ON ARROW ROAD WORK

Lewiston — N. A. Dergstrom, Spokane contractor, was the apparent low bidder on a contract to widen and straighten 3.1 miles of State Highway 3 between the old Snalding bridge and Arrow, the State Highway Department reported Tuesday, Nov. 21. The firm bid \$890,-

284.45. Included in the contract is another project, laying a permanent asphalt surface on U. S. Highway 12 from Coyot Gulch to Spalding. This is a distance of 1.2 miles.

The Spalding to Arrow project on State Highway 3 involves construction of a new 40-foot-wide, two-lane roadway, drainage structures, a 132-foot bridge over Catholic Creek, a 66-foot bridge over Arrow Gulch and laying an asphalt-treated base, a plant-mix bituminous surface and a seal coat.

Donald L. Cox, Lewiston district engineer for the department, said if the bid is approved, construction could begin in about four weeks. It probably will begin first along high bluffs where there are sharp curves in the present bluff.

Ten bids were opened at the department's Boise office. Runner-up bidder was Murphy Bros. of Spokane with \$960,026.50, and third was Max Kunej, also of Spokane, with \$977,204.70.

Contractors were given alternate choices of crushing rock taken from a big cut to be made at the east end of the project at Arrow, or crushing rock from a gravel bar in the adjoining Clearwater river and wasting the rock from the cut. In highway terminology, when material is wasted, it usually is dumped into a gulch somewhere beside the highway to provide a widened fill.

Cox said each of the three lowest bidders chose the plan of crushing rock from the cut, in submitting the lower of their two alternate bids. — Lewiston Tribune.

GRANGE TO MEET

The Kendrick Grange will hold its next meeting on Tuesday, Dec. 5th.

We feature Golden Grain Dairy Products. Blewett's, Kendrick. adv

You know you've brushed when you brrrrush with Broxodent® FROM SQUIBB

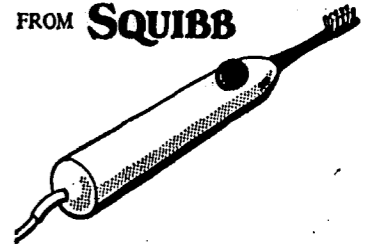

RED CROSS PHARMACY

Phone 289-5941 Kendrick

SAVE \$25*

*From manufacturer's suggested list prices on individual items.



COMPLETE WEEKEND WOODCUTTER'S KIT INCLUDED WITH THE PURCHASE OF ANY McCULLOCH LIGHTWEIGHT SAW

10 Handy Accessories! Extra saw chain, fuel can, bar guard, flat file, round file, depth gauge, wedge, engine oil, fuel additive, and filing guide.

WEIGHS ONLY 11 1/2 POUNDS (less bar and chain)

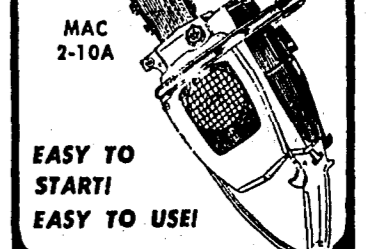

McCULLOCH 2-10A LIGHTWEIGHT CHAIN SAW

NOW ONLY \$149.95

- Easy Starting—DSP releases compression
- Safe Starting—Exclusive "Safe-T-Start"
- Easy to Use—Lightweight, perfect balance
- Automatic oiling of bar and chain
- Extra convenience, low price!

FREE!

Ask for It! 1967 College & Pro Football Guide 300 Colleges, NFL, AFL teams, schedules, records, past, present. 96 pages.

MAKE THIS A WIG CHRISTMAS
\$9.95 TO \$215
Easy Payment Plan
Kendrick Beauty Salon
MARY LOOMIS, Owner-Operator
289-5727

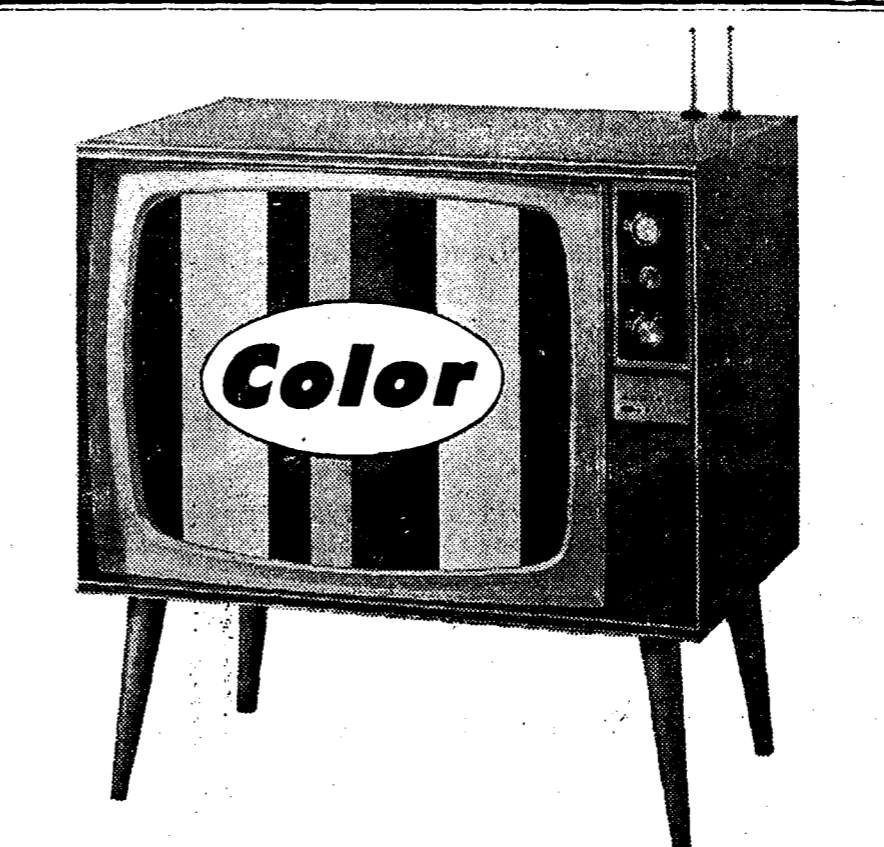

Admiral.
The CALDWELL Model C5311
Quality Color Television
Featuring AFC and Instant Play
295 Square Inch Picture Area (23" Picture Measured Diagonally)

- New Admiral Automatic Fine Tuning . . . "locks in" perfect color pictures everytime.
- New Instant Play operation.
- Admiral Advanced "Q-20" Color Chassis . . . reserve power for sparkling bright pictures.
- Admiral Simplified Control Center with Lighted Channel Indicators.
- Admiral "Super Scope" VHF Tuner with Transistorized UHF Tuner.
- New Admiral Chroma-Brite 23" Rectangular Color Picture Tube . . . rare earth phosphor gives you vivid color pictures.
- Admiral Automatic Degaussing Circuit eliminates impurities caused by stray magnetic fields.
- New Automatic Chroma Circuit . . . maintains correct color intensity.
- High Gain 3-Stage Amplifier . . . exceptional signal sensitivity for best picture clarity.
- Admiral Color Fidelity Control . . . dial new warmth into color and black and white TV pictures.

Handsome contemporary styling. Model C5311 Walnut grained finish on metal.
Dimensions: 28 3/4" high, 28 3/4" wide, 19 3/4" deep.
(Add 3" to depth for tube cap).

GEORGE F BROCKE & SONS INC.
PHONE 289-5983 TV Store KENDRICK



almost anybody can play Santa Claus with a First Security BankAmericard

A First Security BankAmericard makes it easy to play Santa Claus. Just walk into any store displaying the First Security BankAmericard "Welcome Here" emblem and say "charge it". No matter how many stores you visit or gifts you buy, you'll receive but one bill for everything. And you can pay for a BankAmericard Christmas as your budget permits. You have 25 free days from the billing date to pay before any interest starts; or, if you wish to take your time, pay as little as \$10 a month.



*Service marks owned and licensed by BankAmerica Service Corporation

ABRAMS HARDWARE
Frank Abrams Phone 4051 KENDRICK

FOLKLORE FOUND IN CITY NAMES

Many Idahoans might be interested in knowing how the city they live in came by its name. When the settlers first arrived in the new, lush primitive area that is now Idaho, they tried to think of suitable names for their little hamlets and villages; some name that was distinct from the other small townships around.

However, if the area reminded them of another place that they were particularly fond of, the name was adopted for their new home. That is how Bern, Idaho, came about. It was the namesake of Bern, Switzerland; and Ferdinand, Idaho, was coined after a settler's homestead in Indiana; as was Genesee, Idaho, named after a garden valley in New York state.

Often for want of a name the people took the closest thing at hand. Such was the naming of Winchester, Idaho, which was dubbed upon seeing a stack of rifles next to a doorway. Chilly, Idaho, became a name when a group of men were in a cabin discussing the establishment of a town when someone came in, saying that it was chilly outside. Hayden Lake, in northern Idaho, was the result of a card game, the winner's name being Matt Hayden. Juliaetta, Idaho, was named after the two daughters of one of the early area residents, Julia and Etta. Kendrick, got its name from the engineer who surveyed the railroad grade into the town, a Mr. Kendrick.

The majority of city titles in Idaho were named after railroad operators or officials, post offices, senators, Indian chiefs, children of the settlers or mining establishments. Today cities such as Grand View, Fruitland and Golden simple show the surge of promotional pride in the state's growth.

Any readers wishing to send in information on legends concerning Idaho town names can address letter to: Idaho Department of Commerce and Development, Statehouse, Room 108, Boise, Idaho 83707.

CATTLE FACE FLY IS REAL PROBLEM

Moscow — With the coming of winter the 1967 face fly season is over for cattlemen, but it's just beginning for some housewives, according to Larry O'Keefe, University of Idaho extension entomologist.

Cattle face flies spend the winter as adults hibernating in sheltered locations such as barns, hollow logs, and the attics and interwall spaces of homes. Infestations are more likely in northern Idaho than in other parts of the state.

"We don't know why, but they hibernate in large numbers and they seem to select certain locations," said O'Keefe. "When this happens to be your home, a real fly nuisance can develop during the winter and early spring. On warm, sunny days the flies become active and a few will find their way into living quarters. Their presence will be annoying, although they don't feed and are sluggish."

Effective control of face flies in the home can be accomplished with insecticides, but it is complicated and difficult to achieve in many cases. Details are provided in a publication from the county agricultural agent.

IDAHO INCOME UP SAYS U. OF I. REPORT

U. of I., Moscow — Total personal

incomes of people in Idaho have risen over a half billion dollars since 1960, according to a University of Idaho report issued by its Bureau of Business and Economic Research.

Dr. Norman Nybrotten, who is the associate director of the bureau, is the author of the report. He states that the per-person income trend in Idaho has compared favorably with other areas but the total for the state has lagged behind because of a slower population growth. Average income per person rose from \$1,894 in 1960 to \$2,398 in 1966, becoming slightly higher than that of Utah, but remaining below other adjoining states.

Wages and salaries account for about two-fifths of the income of which about 22 percent is derived from public payroll, according to Nybrotten. Almost one-fifth of the total salaries and wages is paid by the wholesale and retail trades. Income from dividends is only about one-third as high as nationally, but rents, royalties and interest are higher in Idaho.

State individual income taxes amount to only about 1 1/2 percent of personal incomes, averaging only \$113.63 per return in 1966. Dr. Nybrotten shows that use of graduated rates, higher rates on higher incomes, has brought about greater increases in income taxes than incomes. He warns that, if personal incomes should decrease, the yield from income taxes would decrease more, percentage-wise.

PENALTIES STIFF FOR CONTINUED LAW VIOLATIONS

W. A. Campbell, local Justice of the Peace points out that laws for continued violations of load, height and similar laws are very severe — and from the Idaho Vehicle Laws of 1961, page 140, Section 49-909 quotes: "Penalties for violations — It shall be unlawful and constitute a misdemeanor for any person to violate any of the provisions of this chapter, and any person convicted of such violation shall be subject to punishment by a fine not to exceed \$100.00 or by imprisonment in the county jail for not more than 30 days and to the cancellation of registration of each motor vehicle operated in violation of any order for the regulation or suspension of traffic issued under the authority of this chapter, and the cancellation of the license of the operator."

Further, Mr. Campbell says that he believes most drivers are not aware of the new violation point count for traffic violations, and he quotes as follows:

Backing without reasonable safety, 1; driving on wrong side of road 3; Flashing red light (failure to stop) 3; Following too closely, 3; failure to obey police traffic order, 2 one-way island (failure to obey the markings) 2; passing on wrong side, 3; passing without sufficient clearance, 3; passing on hill crest, 3; passing at intersection or grade crossing, 3; passing with view obstructed, 3; passing violation of white line, 4; failure to yield right of way at an intersection, 3; failure to yield right of way on left turn, 3; failure to

yield right of way from private road, 2; failure to yield right of way to an emergency vehicle, 3; failure to yield right of way to pedestrian, 3; right of way failure to use due caution for pedestrian, 3; failure to stop at railroad crossing by school bus, bus or gas truck, 2; and failure to stop for a school bus, 4.

In the line of "variable point violations" are: Failure to signal, 3 to 4; speeding, 3 to 4; failure to reduce speed for curve or hillcrest, 3 to 4; violation of posted bridge speed, 3 to 4; failure to obey local posted speed zone, 3 to 4; failure to stop at stop sign, 3 to 4; failure to stop when coming from alley, 3; pulling out from curb without being safe, 2; failure to obey traffic light, 3; turning right from wrong lane, 3; turning left from wrong lane, 3; turning without 500 feet visibility, 3; failure to yield when being passed, 3; failure to yield when entering through highway, 3.

He recommends that all study the law and obey it.

He added that the law says: Departmental action indicated by accumulated violation points — Total of 6, first letter addressed to licensee; total of eight, personal interview or examination; total of 12 or more, license suspension.

IDAHO HISTORY

A Shoshoni Indian girl, born in the high mountains of Idaho a year before the election of the first president of the United States, was destined to fulfill the dream of "America's Manifest Destiny."

Sacajewea was born west of the Great Divide, although her people spent nine months of each year at the foot of the Rockies on the Great Plains. They shuttled back and forth over the divide to spend the summer months in the lands of the "Singing Mountains" known as Idaho.

The young Indian girl was nearing her 12th year when she was taken captive at Three Fork village by a group of Indian warriors. Three years later she and a captive Shoshoni companion, Otter Woman, were auctioned as slaves at Mandan. A French-Canadian, Toussaint Charbonneau, bought both girls. He married Otter Woman at once and forced Sacajewea into marriage a year

later.

In October of 1804 the Lewis and Clark expedition landed in Mandan and became acquainted with the Frenchman and his squaws. Charbonneau and Sacajewea were employed by the two Virginia-born captains as guides. A year later the company marched into Idaho.

Sacajewea's diplomacy saved the expedition from suspicious warring tribes and enabled the captains to purchase horses from her people. Her reward was a reunion in the Idaho mountains with her brother and father of the Shoshoni tribe.

IT'S NO JOKE, HUMOR SOOTHES

Music may have charms to soothe the savage breast, but humor does it better, two University of Rochester psychologists report. In a study of 50 undergraduate men they found that anger and anxiety are significantly lessened by exposure to any kind of humor. Paradoxically, they found, humor's soothing effects are greatest when the jokes are hostile, sarcastic and insulting and that angered people tend to appreciate hostile jokes more than non-angered people do.

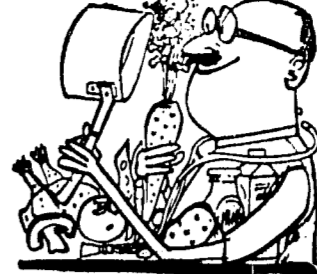

Doctor in the Kitchen

by W. W. Bauer, M.D.
Consultant, National Dairy Council

DIET AND ACNE

One of the points that is always stressed for medical students is that where there are many varieties of treatment for any condition, it is a reasonable supposition that none of them is highly successful. If one were, the others would be forgotten.

So it goes with acne, the plague of youth.

This "skin" disease, so distressingly common in adolescent boys and somewhat less so in girls, is not really a skin disease. It is a general condition manifesting itself most annoyingly in the skin eruption. It is essentially a by-product of the changes inherent in moving into manhood or along the way to womanhood.

Glands Active
At this time, the glands of internal secretion are especially active in guiding the maturing of the body and the establishment of the adult pattern of sexuality. Among other glands stimulated are those of the skin, especially the oil or sebaceous glands.

There is no need to describe acne. Everyone knows what it looks like and how it acts. The question is, what to do about it? The usual answer, "You'll outgrow it" is met with the scornful rejoinder, "Yeah, but I've got a date this Saturday night!" And who can blame the guy or the gal!

Among other forms of treatment has been an effort, or many efforts, to control acne through diet. Usually the result is that

a good diet is little or no help, but an unbalanced diet makes matters worse. Suspected foods are the fatty ones, the fried ones, the chocolatey ones and the sweet ones. But take out these foods from the adolescent diet, and what have you got? You've got revolution!

Distorted Report

A recent report attributing acne to milk was based on young people who drank up to four quarts of milk a day, to the detriment of the well-balanced diet which they should have had. Their acne was blamed on the milk. It should have been blamed on the quarts! No one recommends such excessive use of one food.

I like the advice given in the Diet Manual of the Nutrition Department, the Presbyterian Hospital, New York City, which says in effect that the best diet for persons with skin disorders is one which is nutritionally adequate, in which the four basic food groups are represented: Meat, eggs, fish, poultry, milk and dairy products, fruits and vegetables, and whole-grain or enriched cereal products. No single food or group predominates in all allergic disorders, and a good diet accomplishes more than hit-or-miss elimination of specific foods.

As to the rest of the treatment, let your doctor decide. And don't pick the pimples!

STOP COLD DRAFTS
EASY-ON
STORM WINDOW KIT
ONLY 39¢ each
EASY TO INSTALL Inside or Outside
Complete—72" x 36" Plastic Sheet with molding and nails.
At Hardware & Lumber Stores Everywhere
Another Warps Plastic Frame in Plastic Since 1924

WANDER INN
TAVERN AND CAFE
HOME COOKED FOOD IC CREAM — FOUNTAIN
WE HANDLE YOUR FAVORITE BEVERAGE
KATIE & BILL OLSON JULIAETTA, IDAHO

C. L. CHEHEY CO.
INVESTMENT MANAGEMENT
116 East Third Moscow Ph. 882-2822

Look what's in store for your teeth!
New Broxodent®
"Deluxe" from SQUIBS

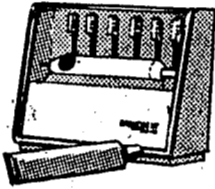

RED CROSS PHARMACY

Phone 289-5941 Kendrick

OPEN EVENINGS BY APPOINTMENT

A new Cut and Set, a perm for lasting body, or a sparkling new hair color. Delightful "French Frosting," so smart. Be glamorous and shine your way through this Gala Holiday Season!

- Deluxe Lanolin Wave \$8.50
- So Soft Moisture Wave \$12.50
- Budget Wave \$6.50

KENDRICK BEAUTY SALON

Phone 289-5727

USED A-1 CARS

- 1966 FORD GALAXIE 2-door hardtop, V-8, automatic transmission, power steering, air conditioning. Factory warranty. Gold \$2695
- 1965 BUICK WILDCAT, V-8, automatic transmission, power steering, power brakes, power seat. A-1. Blue \$2195
- 1965 PLYMOUTH Fury III, V-8, automatic transmission, power steering, air conditioning. A-1. Blue \$2295
- 1965 OLDSMOBILE F-85 Deluxe 4-dr. V-8, automatic transmission, power steering, power brakes. A-1. White \$1895
- 1965 MUSTANG Hardtop. V-8, 4-speed. Bronze \$1995
- 1965 FORD F-250. V-8, 4-speed. Long and wide. Blue \$1995
- 1966 FORD F-250. V-8, 4-speed. Long and wide. Green \$2295

DELTA FORD SALES
CORNER MAIN & TROY HIGHWAY
116 E. 2nd MOSCOW, IDAHO TU 2-1489
WHERE GOOD WILL IS IMPORTANT

LOOKING FOR
TOP QUALITY AUTO INSURANCE
at a
NEW LOW COST ?
Let us tell you about the new
FACESETTER policy
R. E. MAGNUSON AGENCY
Phone 289-4271
KENDRICK, IDAHO

COMMERCIAL PRINTING

LETTERHEADS
ENVELOPES
STATEMENTS
BUSINESS FORMS
RULED FORMS
BOOKLETS
WINSTON LINE WEDDING STATIONERY
THE KENDRICK GAZETTE

THE KENDRICK GAZETTE

Published every Wednesday afternoon (dated Thursday) at Kendrick, Idaho, by W. L. McCrea...



CHURCH NOTICES

Lutheran Church of Cameron Theo Meske, Pastor Sunday School at 9:45 a. m. Worship Service 10:45 a. m.

Lutheran Church of Juliaetta Theo Meske, Pastor Sunda School 8:30 a. m. Worship Service 9:30 a. m.

Kendrick Community Church Frank Lepinski, Pastor Church School 9:45 a. m. Worship Service 11:00 a. m. Christmas Music Dec. 10, 8 p. m.

Juliaetta Methodist Church Frank Lepinski, Pastor Church School 10:30 a. m. Worship Service 9:30 a. m.

Leland Methodist Church Frank Lepinski, Pastor No service. Worship at Juliaetta or Kendrick.

Juliaetta Seventh Day Adventist Pastor Wallace Mandigo Sabbath School 2:00 p. m. Church Services 3:00 p. m. Bible Study, Tuesday, 7:00 p. m.

Kendrick Assembly of God Clarence Shoop, Pastor Sunday School at 9:45 a. m. Morning Worship at 11:00 C. A. Youth Meeting 6:30 p. m. Evangelistic Service 7:30 p. m. Bible Study, Wednesday, 7:30 p. m.

ATTEND WEDDING — Mr. and Mrs. Jerry Smith and family attended the wedding, Saturday, of her cousin, Miss Mildred Stone, daughter of Mr. and Mrs. Robert A. Stone at Milton-Freewater, Ore. She married Daniel Hansen of Walla Walla, a student at Gonzaga University in Spokane, where the couple will live. The wedding was the opportunity for a family reunion. Also attending were Mrs. Smith's parents, Mr. and Mrs. Charles D. Stone of Boise, and an uncle and aunt, Mr. and Mrs. Lambert Maher of Newberg, Ore., and their two children. One cousin, a sister of the bride, Mrs. Betty Ann Wallace of Gallatin, Tenn., had not seen the entire family for 17 years.

FIX RIDGE NEWS

MRS ADOLPH DENNLER Home 976-3740

Mr. and Mrs. Hans Harder, Barbara and Mary of Spokane were Wednesday over-night guests of Mr. and Mrs. Tom Dennler.

Saturday, Nov. 18, Mr. and Mrs. Bruce Giese and children visited with Mr. and Mrs. Geo. Giese, Mr. and Mrs. Chet Woodruff and Mr. and Mrs. Martin Poelson in Lewiston.

Mr. and Mrs. George Giese were Thanksgiving dinner guests of Mr. and Mrs. Bruce Giese, also helping Cathy celebrate her birthday.

Mr. and Mrs. Tom Dennler, John and Mark, Mr. and Mrs. Hans Harder, Barbara and Mary, Rev. and Mrs. Otto G. Ehlen were Thanksgiving dinner guests of Mrs. Kuni Dennler, in Lewiston.

Mr. and Mrs. Adolph Dennler and Debra were Wednesday over-night guests of her brother-in-law and sister, Mr. and Mrs. Horace Rainey and family in Portland. Thursday both families drove to Eugene to enjoy Thanksgiving dinner with another brother-in-law and sister, Mr. and Mrs. Chester Cramblet and family. Mr. and Mrs. Dennler and Debra were Thursday and Friday guests of the Cramblets, and Saturday over-night guests of the Rainey's, returning home Sunday.

Mr. and Mrs. Gary Browning and

SAVE TIME Shop the CLASSIFIED

FOR SALE — 3 bedroom house in Juliaetta. Phone 276-3380. 46-1f

NOTICE — To Our Customers — The Kendrick Beauty Salon is now open on Mondays and evenings by appointments. — Mary Loomis and Sharon Harris, operators. Phone 289-5727. 48-1

FOR RENT — 2-bedroom apt. Richard Groseclose, 276-3661. 48-3x

FOR SALE — Jeep with tow-bar. Harlan Fey, phone 289-4644. 48f

FOR SALE — 2 single kids beds, mattresses and springs. A mother cat and 4 kittens free. Werner Brammer, Kendrick. 47-1f

HOUSE FOR RENT — 4 bedrooms. Call Howard or Walter Wolff. -1

FOR SALE — New home, 2 bdm, full bsmt, \$16,000. Juliaetta. Jay Fowler. 39-13x

FOR RENT — 1 bedroom furnished apartment at Juliaetta. No pets or children. William C. Swan 37f

FOR SALE — Cracked Eggs. Bring your container, 35c doz. AA-Large 50c doz. Tuesdays & Fridays. Howard Wolff. 41-152x

RUDY'S SAND & GRAVEL—Drive-way Gravel, Rock 276-3251 10-1f

FOR LOWEST PRICES read the ad. of Blewett's Grocery Market on the back page. adv.

WANTED — CHURNING CREAM. Lewiston price at Kendrick. Leave at Kendrick Table Supply, Kendrick. Golden Grain Dairy, Lewiston. tf

GLASS — Auto Glass, Windshields, House Glass and Mirrors. C. F. Little Auto Shop, Kendrick. Phone 289-5547 41-1f

PROPANE GAS SERVICE — Ralph Reid, Kendrick. 47-3

children were Thanksgiving dinner guests of Mr. and Mrs. Roy Glenn in Kendrick.

Mrs. Maice Nye was a Thanksgiving dinner guest of Mr. and Mrs. Bert Nye and children. The weather is sure chilly this morning (Monday) 10 above!

MORE JULIAETTA

(Continued from page 1) Mr. and Mrs. R. E. Woody and Mrs. David Peterson were Thanksgiving guests in the home of Mr. and Mrs. Arnold Hoisington, Fairview.

Those visiting in the home of Mr. and Mrs. Willard Bowen over the week-end were Burton Bowen of La-Center, Wn., and Charlene Minion of Beaverton, Ore., and Mr. and Mrs. Byron Bowen and Tim of Lewiston, the latter were Sunday dinner guests.

Mr. and Mrs. Gil Erlwine returned Monday from Polson, Mont., after spending Thanksgiving with their son and daughter-in-law, Mr. and Mrs. Gerald Erlwine.

Thanksgiving dinner guests in the A. C. Cook home were Mr. and Mrs. Wm. Amsbaugh and Mr. and Mrs. Bob Cook and family, Lewiston; Mr. and Mrs. Arnold Zimmerman and family, Deary; Mr. and Mrs. Lloyd Cook and son, St. Maries; Mr. and Mrs. Lee G. Inolds of Libby, Mont., who were Wednesday to Sunday guests; Mr. and Mrs. Leonard Cook, Avery, were Wednesday to Friday guests, and Mr. and Mrs. Asa Cook, and family were Thanksgiving Day callers. Sunday afternoon Mr. and Mrs. Jack Bird visited the family.

Mr. and Mrs. Earl Loomis and sons were Thanksgiving Day guests of his brother, Ray Loomis, at St. Maries.

Thursday Rev. and Mrs. Elton Hilliard, Janis and Brenda went to Nampa to spend Thanksgiving with their son Bob and daughter Nancy, who came from Turlock, Calif., to join them. Bob had just gotten out of the Mercy Hospital, following an attack of pneumonia.

Thanksgiving visitors in the Lloyd Holbrook home at Piggins included Mr. and Mrs. Lyle Pea and family, Wednesday to Saturday; Mr. and Mrs. Wm. Lublow, Thursday to Saturday, and Mr. and Mrs. Brent Holbrook and children of Lewiston, Wednesday and Thursday.

Thanksgiving dinner guests in the Clyde Davis home were Mr. and Mrs. Lester Marks of Harvard.

NOTICE OF ELECTION OF CEMETERY DISTRICT COMMISSIONER

NOTICE IS HEREBY GIVEN That an election of NezTah Cemetery Maintenance District Commissioner will be held in the said District on Monday, December 4th, 1967, at the City Hall, Village of Kendrick, Latah County, Idaho, at which time One Commissioner from Sub-District No. 3 will be elected for a term of four years.

The commissioner sub-districts are as follows: Juliaetta and Fix Ridge, Sub-District No. 1; Bear Ridge, Sub-District No. 2, and American Ridge, Kendrick and part of NezPerce County, Sub-District No. 3. Polls will be open from 1:00 o'clock p. m. until 5:00 o'clock p. m. of said day. Nominations may be made by petition with not less than 20 names on said petition and filed with the secretary up to and including the 30th day of November, 1967, for said nominees names to be placed on the ballot.

Dated this 4th day of November, 1967. WALTER DENNLER, Secretary. First pub. Nov. 9, 1967. Last pub. Nov. 30, 1967.

NOTICE OF SALE OF REAL AND PERSONAL PROPERTY AT PRIVATE SALE IN THE PROBATE COURT OF THE COUNTY OF LATAH, STATE OF IDAHO

In the Matter of the Estate of TEDDY J. PETERS,

An Incompetent Person NOTICE IS HEREBY GIVEN that the undersigned guardian of the person and estate of Teddy J. Peters, an incompetent person, will sell on or after the 11th day of December, 1967, in the County of Latah, State of Idaho, to the highest and best bidder, and upon the terms and conditions hereinafter mentioned, at private sale, subject to confirmation by the above entitled court, the following described real property belonging to the estate and said incompetent person situated in the County of Latah, State of Idaho, to-wit:

Lots One (1) and Two (2), Block Three (3), Original Town of Juliaetta, Idaho, according to the recorded plat thereof, together with the following described personal property, belonging to the estate of said incompetent person situated upon the above described premises, to-wit:

All fixtures, equipment, tools and personality of every nature used for the conduct and operation of a motor vehicle service station and repair business on said above described premises. Terms and conditions of sale: Cash, in lawful money of the United States, upon delivery of the deed by the undersigned guardian and after confirmation of the sale by the above entitled court; title insurance will be furnished.

Bids must be in writing and must be accompanied by a cashier's check payable to the guardian in the amount of ten per cent (10%) of the amount bid. Bids are to be left at the office of the attorney for the guardian, Frank V. Barton, (P. O. Box 573) 622 Main Street, Lewiston, Idaho, or may be delivered to the guardian personally, or may be filed in the office of the clerk of the above entitled court, at any time after the first publication of this notice and before the making of said sale. The undersigned guardian reserves the right to reject any and all bids.

DATED this 18th day of November, 1967. CAROL M. PETERS, Guardian

First pub. Nov. 23, 1967. Last pub. Nov. 30, 1967.

STONY POINT ITEMS

MRS. ERNEST STEIGERS Phone 46-3396

Thanksgiving dinner guests in the Newt Heath home included the Kenneth Rugg family and the Donald Heath family, all of Lewiston; the Bill Ingraham family of Richland, Wn., who spent the Thanksgiving week-end with them. Saturday dinner guests were a grandson, Scott Gibbs, Seattle, and a girl friend from Denver, Colo. Mr. and Mrs. Lee Montgomery of Lewiston and Mr. and Mrs. Don Johnson and Kenneth of Lenore, were Sunday afternoon callers.

rs. Newt Heath returned to Lewiston for her post-operation examination on Monday. She is recovering nicely.

The Wayne Heimgartner home was the scene of a large family gathering for Thanksgiving. Besides their sons Allen and Harold, who were home from the U. of I., there were the following guests: The Wm. Harter family, Mrs. Leslie Brown and daughters, Everett Heimgartner and the Ronald Heimgartner family, all of Clarkston; Mr. and Mrs. Dean Rynearson, Starbuck, Wn.; Mr. and Mrs. John Surbaugh and family of Othello, Wn. The Surbaughs were over-night guests. Mrs. Lilly McCall was a Thursday supper guest.

Saturday night the Wayne Heimgartner family were supper guests in the Raymond Heimgartner home, Lewiston.

Mr. and Mrs. Roy Heimgartner and sons spent Thanksgiving with her parents in Coeur d'Alene. Sunday morning Leslie Heimgartner and Mr. and Mrs. Roy Heimgartner left for Seattle where Leslie will undergo hearing tests and possible surgery for the same. Enroute they planned to spend the night with the Bob Heimgartners at Yakima.

The L. L. Maguire family, Venetia, have started their return journey, after an extended visit with his parents, Mr. and Mrs. L. L. Maguire, Sr., Lenore, and other relatives.

Mr. and Mrs. Kenneth Steigers and daughter and Mr. and Mrs. Ernest Steigers spent the holidays at Bothell and Kenmore, Wash., in the home of their daughters' family, the Loren Ratliffs. While there they visited in the other homes including the David Talbot, Henry Steigers and Don Coulter, in surrounding areas.

Mrs. Cecil Daniels spent Monday morning, Nov. 20, in the E. Steigers home.

Word has been received of the death in a one-car accident, of Miss Bonnie Mae Swan, 18, daughter of Mrs. Marie Swan Webb, Coeur d'Alene. Mrs. Webb will be remembered as Frances Marie Daniels. The car's driver, another young woman, also met death in the accident.

The Eldon Heimgartner's three sons and many others were present in their home for Thanksgiving dinner. These included: The Gerald Heimgartners of Lewiston; Mr. and Mrs. Albert Heimgartner and Earl; Mr. and Mrs. Alvin Steigers, Gifford; Mr. and Mrs. Everett Custer, Pullman; Mr. and Mrs. Marion Stevens. Eugene Heimgartner of Pilot Rock, Ore., and three children were week-end visitors.

Larry Heimgartner was home from E. W. C. E. Cheney, Wn. Mr. and Mrs. Eldon Heimgartner spent Sunday evening in the home of their son Gerald, Lewiston.

Fern Stevens came home from the U. of I. to spend Thanksgiving with the Elton Ankeny family.

The Kerby young folk were home for the holidays.

Virgil Stevens called his parents from Ithaca, N. Y., Thanksgiving.

Mr. and Mrs. Glenn Stevens spent the holidays with their daughter Glenda and husband — the Carpenters, near Portland. They were joined there by their daughter Linda, a student at Kirkland, Wn. Mrs. Effie Powell accompanied them for the visit.

Mr. and Mrs. Cletis Hoisington visited the past week and celebrated Thanksgiving with their son Phil and family in Eugene, Ore.

GOLDEN RULE

BY ALMA BETTS

Mr. and Mrs. Gene Kuykendall and daughters, Mr. and Mrs. Herman Kuykendall and family, Mr. and Mrs. Gene Holliday and daughter were Thanksgiving guests of Mr. and Mrs. D. V. Kuykendall.

Mr. and Mrs. Oscar Lawrence were guests Thanksgiving of Mr. and Mrs. Albert Lawrence and family.

Mr. and Mrs. Russell Perkins were Thanksgiving guests of Mr. and Mrs. Don Cantril, Kendrick.

Mr. and Mrs. George Finke spent Thanksgiving in Pierce with Mr. and Mrs. Dick Watson and sons.

Mr. and Mrs. B. A. Kite, Orofino, spent Thanksgiving with Alma Betts. John Martin went to the Emma Weichmann home Monday, to return on Friday.

Mrs. D. V. Kuykendall and Mrs. Russell Perkins attended a missionary meeting at the Wayne Yenni home, Tuesday afternoon.

Alma Betts spent Tuesday in Orofino with her daughter, Mrs. Don Christensen, and sister, Mrs. B. A. Kite.

Mr. and Mrs. Jerry Lumper and Mrs. Mildred Wright of Orofino, and Henry Hasse visited at the Alma Betts home Tuesday evening. Mrs. Wright came Saturday to make her home at the Betts' for an indefinite time.

Mr. and Mrs. D. V. Kuykendall and Mr. and Mrs. Russell Perkins attended the Raymond Blankenship funeral in Lewiston, Wednesday.

Mr. and Mrs. Gerald Kuykendall and family were Sunday visitors in the D. V. Kuykendall home.

Mr. and Mrs. Lloyd Martinson and Rocky of Moscow visited his brother, John, Sunday.

Mrs. Claude King and Georgia Reece were Sunday dinner guests of Alma Betts.

Mrs. Russell Perkins and Mrs. D. V. Kuykendall went to the Teakane Grange Saturday night. There will be a pot-luck dinner the next meeting, with roast turkey at 6:30—

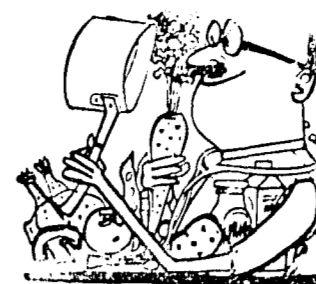

Doctor in the Kitchen

by W. W. Bauer, M.D. Consultant, National Dairy Council

MILK FOR ATHLETES

When there is a difference of opinion among supposedly qualified persons, the best way to settle it is not by argument, but by scientific study.

Athletic coaches have held differing opinions about the values of milk for athletes in training for varsity or Olympic competition. Some have held that the competing, and often still growing athlete needs his milk as much or more than does the person who is not engaging in physically demanding sports. Others have taken the view that milk interferes with athletic performance.

Why The Objections

The specific objections raised to including milk in the diet of athletes were as follows:

- a) milk reduces the secretion of saliva and creates a dryness of the mucous membranes called "cotton mouth";
b) milk consumed within a few hours before competition curdles in the stomach and interferes with maximum performance;
c) milk in the athlete's diet raises his fat intake and lowers his breathing efficiency, and so decreases his performance capability.

Two Research Studies

Two separate and independent studies were initiated to establish the facts in this controversy. One was conducted at Michigan State University, East Lansing; the other at the University of Utah at Logan. At Michigan State the study was conducted with the aid of seven freshman track candidates and two experienced en-

duration runners. At Utah the subjects were 24 athletes representing the competitive sports of football, basketball, track and field, and wrestling.

Without going into all the details of the scientific procedures of the two studies, it is of interest to note that in each instance the subjects studied were divided into two groups. One group had plenty of milk and milk products, the other, for comparison, had the products omitted from their diets except as milk was used in cooking.

Comparisons Made

Comparisons were then made between the groups with respect to ability to run, on a treadmill or track, and other athletic performance, and they showed definitely that the group which had the liberal intake of milk was not affected adversely in any way, even when the milk was taken immediately before competition.

At Michigan State, it was found that the group from whose diet milk was eliminated tended to replace the lost calories with foods of inferior nutritional value, primarily carbohydrates.

Nutrients Far Low

The level of desirable nutrients, especially calcium and riboflavin, fell below desirable level. The claim that milk produces dry mouth and excessive gas formation was definitely disproved, and it was demonstrated that there are valid reasons for including milk in the diet of athletes.

So another rumor is laid to rest.

Dec. 9th, and a Christmas gift exchange. A large crowd is hoped for.

Mr. and Mrs. Ray Charpentier were in Lewiston, Wednesday. They were supper guests of their son Leonard; visited a son Bernard and family, and her mother, Sidney Butts at the Orchards Nursing Home. Thursday they were guests of Mr. and Mrs. Otto Riggers, joining other relatives for dinner. They returned home on Friday.

Mrs. Albert Lawrence was a Lewiston visitor Monday, Bonnie spending the day with Alma Betts.

Mr. and Mrs. Russell Perkins were in Lewiston Sunday, attending the Golden Wedding Anniversary of close friends.

Happy birthday goes to Emma Hasse today (Tuesday), 89 years young. She has made her home with Alma Betts for the past five years.

Homemakers Club

Extension Homemakers — Don't forget the Husband's Dinner, Saturday evening, in the home of Mr. and Mrs. Rollin Armitage. There will be an exchange of "gag gifts."

NEWS BRIEFS FROM AMERICAN RIDGE

MRS. GEORGE HAVENS Phone 289-4139

Mr. and Mrs. George Havens and Mr. and Mrs. Don Havens of Spokane, visited Tuesday afternoon with Mr. and Mrs. Carl Fisk in Orofino and saw the Dworshak Dam work.

Miss Judy Mills and Eric Henningsen, U. of I., Moscow, were weekend guests in the Geo. Havens home. Thanksgiving guests of Mr. and Mrs. Werner Brammer were Mr. and Mrs. Geo. Havens, Mr. and Mrs. Walter Koepp, Mr. and Mrs. Skip Koepp, Mr. and Mrs. Henry Brammer, Roy Ramey and Rayner Havens. Ernest Brammer was an evening caller.

Mrs. Nona Nelson returned to her home in Clarkston, Thursday evening, after spending the past week with Mr. and Mrs. Frankie Benschoter.

Wednesday, Thursday and Friday guests in the Frank Benschoter home were Mike, Kristie and Dana Benschoter of Lewiston.

Thanksgiving guests of Mr. and Mrs. Edd Kent were Mr. and Mrs. Wm. Holt, Mrs. Kathryn Morey and sons Pat and Mike; Mr. and Mrs. Howard Holt, Mr. and Mrs. Bert Sundstrom and son Randy, Deary.

Thanksgiving dinner guests of Mr. and Mrs. Frankie Benschoter were Mr. and Mrs. Don Benschoter and family, Mr. and Mrs. Ray Benschoter and family and Dr. Dan Guy, all of Lewiston, and Mrs. Nona Nelson of Clarkston.

Mr. and Mrs. Wayne Davis and Joy visited Friday afternoon with Cal Whitney in Greer, and also called on Mrs. Whitney, who is a patient in the Orofino Hospital.

Mrs. Ida Paulsen, Troy, was a Sunday guest of Mrs. Ella Benschoter.

Don Benschoter was a Tuesday caller in the Frank Benschoter home.

Mr. and Mrs. Andy Cox returned Saturday from a three-week trip to Washington, D. C., where they attended the National Convention of the Order of Eastern Star. They also visited New York, Chicago and Lansing, Mich., where they took delivery of a new car and drove it home. They report a wonderful time.

Mrs. Ella Benschoter and Mr. and Mrs. Dick Benschoter and Lesley attended the wedding of Linda Benschoter and James Bunch in Spokane, Wednesday evening, Nov. 22. They remained and spent Thanksgiving with family members.

Mr. and Mrs. Walter Benschoter

spent Thanksgiving in the home of their son, Mr. and Mrs. Jack Benschoter and family, Pullman.

Thanksgiving guests of the Wayne Davis family were Mr. and Mrs. Bert Davis, Mr. and Mrs. Milburn Storey, Mr. and Mrs. Stewart Fockler, all of Pullman; Mrs. Esther Fowler, Tom, Penny and Dan; Mr. and Mrs. Dale Yarnell and Suzie, all of Spokane, and Mr. and Mrs. Harry Jones Moscow.

The Warney May, Jr., family enjoyed Thanksgiving dinner with Mr. and Mrs. Roy Glenn in Kendrick. Their entire family was home for the occasion.

Sunday dinner guests in the Frankie Benschoter home were Ray and Mike Benschoter and Dave Bream all of Lewiston.

Mr. and Mrs. Edd Kent, Mr. and Mrs. Wayne Davis and Mr. and Mrs. Frankie Benschoter attended a house warming honoring Mr. and Mrs. Archie Morgan in Lewiston, Saturday evening. The Morgans have recently moved to Lewiston from Moscow.

Mr. and Mrs. Harold Olderness and Mr. and Mrs. Dick Cuddy were dinner guests in the Wayne Davis home Sunday.

Ray Benschoter and Mike Everette, Lewiston, were Wednesday supper guests of Mr. and Mrs. Frankie Benschoter.

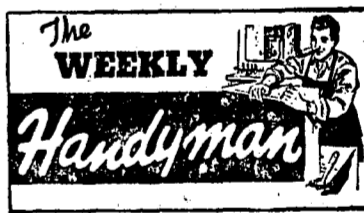

A Service Of The Thor Research Center For Better Farm Living

A worthwhile one-evening project is the construction of a hall tree. Easy to make by utilizing portable electric tools such as saw, jigsaw and table, and drill, a hall tree is an ideal substitute for closet space for hanging coats, hats, and jackets, near the recreation room where neighborhood youngsters and adult guests congregate.

The hall tree can be made from any type of wood, depending entirely on where you intend to use it. You'll need an 1 1/2-inch length of 2x12 for the base, 6 feet of 2x2 for the upright and base feet, and a few feet of 3/4-inch dowel rod for hanger pegs.

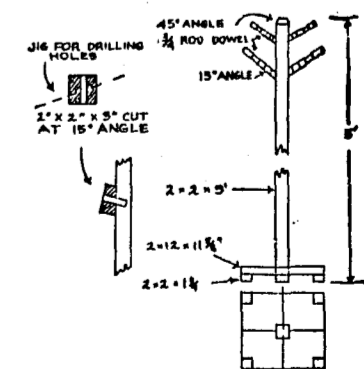

Hall tree is a one-evening project for a handyman with proper electric tools.

Since finished lumber always is somewhat smaller than the actual size designation, the 2x12 really is 1 1/2 inches wide and, by using an 1 1/2-inch length of that lumber, you'll have a square base. When you make the square hole in the center of the base to insert the upright, remember that a 2x2 actually is 1 1/2 inches square, so the hole should be that size.

PARK PATTEN

BY MRS. JERRY SMITH

THANKSGIVING — There was much traffic in Park over the weekend, with most visitors combining visiting with hunting.

Visiting Charles Jelleberg were Mr. and Mrs. Tom Mabbott and Jerry Blatter of Juliaetta, Saturday.

At the Smith home were Mr. and Mrs. Clinton Smith and Kay of Lewiston and Chas. Jelleberg.

Mr. and Mrs. J. D. Baumgartner and family spent Thanksgiving with Mr. and Mrs. W. D. Kirk and family in Deary.

Most of Mr. and Mrs. Chas. Engers family were home.

OUR USUAL VALUES & PRICES

It Should Be Worth Your While to Visit Our Big Lot

CARLSON'S USED CARS — TROY Phone 835-2141 — Troy Nights 835-3358

FRANK V. BARTON LAWYER Office in Postoffice Building Phone 289-4981 KENDRICK, IDAHO Wednesdays: 9 a. m. to 5 p. m.

COMPLETE TONSORIAL SERVICE Our Aim Is To Please

DICK'S BARBER SHOP DICK CUDDY KENDRICK

Dr. D. A. Christensen M. D. Office Hours 10:00 A. M. To 5:00 P. M. Emergency Calls at All Hours On Notification Office Phone 5682 Residence 5871 Office in Christensen Building Kendrick

SHIP BY TRUCK Door-to-Door Delivery Fast, Safe, Dependable

WALTER BROCKE OFFICE PHONE 289-5983 RESIDENCE PHONE 289-5981

BENDEL'S MEAT PACKING PLANT Custom Slaughtering Meat Cut, Wrapped and Quick Frozen Locker Beef by Half and Quarter (Animals Should Be In Not Later Than Monday) Live Pick up Can Be Arranged 4 Miles East of Troy on Troy-Deary Highway Ph. TE 5-2341 Eve. 882-3960

76 UNION 76

**For the Best in Quality
PETROLEUM PRODUCTS**
Call 289-4251

Royal 76 or Regular Gasoline
Unifuel — the low sulphur content Diesel
Lubricating Oils and Greases
For Every Need!

Call 289-4251

BILL ROGERS DISTRIBUTOR

**WHEN WINTER'S CHILL CATCHES UP
WITH YOU —**
And you get to thinking of a Good Hot
Meal — a Sizzling Steak — or Just a Real
Quick Lunch — Think of Us!
Or when that "Sweet Tooth" speaks up —
for a Sundae, Soda or Ice Cream — Think
of Us!
WE LOVE TO FEED THE HUNGRY!
COUNTRY KITCHEN
Marion & Ellen Rowden Kendrick

GIFTS FOR ALL THE FAMILY

CHRISTMAS SURPRISES



**FIRST SECURITY
BANK/AMEX/CARD**
welcome here

**MAKE AN EARLY SELECTION
USE OUR LAY-AWAY PLAN**

TRY US FIRST AND SAVE!
OLDERNESS DEPT. STORE
PHONE 289-5791 KENDRICK

**CAMERON SECTION
ACTIVITIES VARIED**

MRS. DOUG. CHRISTENSEN
Phone 289-5877

Baby Baptized
Jack Theodore Meyer, infant son of Mr. and Mrs. Ted Meyer, was baptized Sunday at the Cameron Emmanuel Lutheran Church, Kenneth Wilken, Miss Hermina Meyer and Mrs. Horst Reil were sponsors.

Christmas Party
The A. L. C. W. Christmas party will be held in the church basement, Wednesday, December 13th, at 2:00 p. m. There will be a gift exchange. Everyone is welcome to attend. Hostesses are Mrs. Ted Meyer, Mrs. Thelma Meyer, Miss Hermina Meyer and Mrs. Martha Wilken.

Students Home For Holiday
JoAnne Schwarz, Lewis-Clark Normal School; Liz Allen, Ted Meske and Don Hepler, U. of I., were among the college students home for the holiday week-end.

Vacationing In Germany
Mr. and Mrs. Horst Reil and Mr. and Mrs. Reinhardt Schroeder and children were taken to Spokane on Monday by Hermina Meyer. They boarded a jet plane early Tuesday morning for Germany, where they will spend the holidays with relatives. The couples will be away about six weeks.

Thanksgiving Activities
Mr. and Mrs. Ted Weyen and Dean were Thanksgiving dinner guests of Mr. and Mrs. Don Hoisington.

Gary Whiting of Lewiston gave a Thanksgiving dinner in honor of several relatives. Those included were Mr. and Mrs. Harl Whiting, Mr. and Mrs. James Whiting, Janis and Gina Rae, Ray Whiting, Nina Whiting, Mr. and Mrs. Norman Whiting and family and Gary's house guest, Jimmy Huffman of Grants Pass, Oregon.

Mr. and Mrs. Aug. Brammer spent Thanksgiving with Mr. and Mrs. Cecil Brammer and family on Cedar ridge. Mrs. Bill Brammer of Clarkston was also a guest.

Mrs. Clay Albright, Mr. and Mrs. Eldon Glenn and family and Mr. and Mrs. Wilbert Brunstiek were guests of Mr. and Mrs. Albert Glenn on Thanksgiving Day.

Bill Mielke of Lewiston was a Thursday dinner guest of Helen and Ted Mielke.

Mr. and Mrs. Charles Havens of Clarkston were hosts for a Thanksgiving dinner. Mr. and Mrs. Ed Mielke were the guests.

Mrs. Thelma Meyer had as Thanksgiving guests Mr. and Mrs. Marvin Siffow and family, Mr. and Mrs. Horst Reil and Mr. and Mrs. Reinhardt Schroeder and family.

Other News
Mr. and Mrs. Ted Meyer entertained at a dinner Sunday evening in honor of their son Jack's baptism. Guests included Mrs. George Wilken, Mrs. Paul Kerbrat and son; Mrs. Hattie Johnson of Peck; Mr. and Mrs. Horst Reil, Mrs. Thelma Meyer and Hermina Meyer.

Mary Meske spent from Wednesday night to Sunday with her parents, Rev. and Mrs. Theo Meske. Mrs. Meske's father, August Siefaff of Ritzville, Wn., also spent the Thanksgiving week-end with the Meskes.

Last Tuesday Mr. and Mrs. Wilbert Brunstiek and Mr. and Mrs. Albert Glenn were dinner guests in the Eldon Glenn home, in honor of Eldon's birthday anniversary.

Mr. and Mrs. Otto Schupfer were Sunday visitors in the Wilbert Brunstiek home.

Miss Linda Newman of Moscow spent the week-end with her parents, Mr. and Mrs. Harry Newman.

Mr. and Mrs. Stanley Hepler and Don were visitors of Mr. and Mrs. Dan McKenzie of Troy, Sunday. Reinhard Wilken and Mr. and Mrs.

Henry Reil were Sunday evening callers of Mr. and Mrs. Horst Reil. Saturday evening dinner guests of Mr. and Mrs. Walter Koopp were Roy Ramey, Ernest Heimgartner, Mr. and Mrs. Gerald Heimgartner and family of Lewiston; Mr. and Mrs. Ron Pryor of Puyallup, Wn., and Mr. and Mrs. Skip Koopp.

Wayne Schoeffler of Orofino and Ray Whiting of Lewiston spent Saturday afternoon with Mr. and Mrs. Harl Whiting. Ray spent the evening with the James Whiting family.

Mr. and Mrs. Harl Whiting visited with Mr. and Mrs. Bob Draper Sunday afternoon.

Mr. and Mrs. Ron Pryor of Puyallup, Wn., spent from Friday through Sunday with her parents, Mr. and Mrs. Walter Koopp.

Mr. and Mrs. Harl Whiting spent Wednesday evening with Mr. and Mrs. James Whiting and daughters.

The Marvin Siffow family, Mrs. Thelma Meyer, Hermina Meyer, Dr. and Mrs. D. A. Christensen were Tuesday dinner guests of Mr. and Mrs. Doug. Christensen and family, in honor of Char's sixth birthday anniversary.

Mrs. George Wilken, Mrs. Paul Kerbrat and son, and Mrs. Hattie Johnson-of Peck were last Tuesday supper guests in the Kenneth Wilken home.

MORE SOUTHWICK

(Continued from page 1)

Callers this week in the Wade Candler home were members of their families, including: Mrs. Aaron Wells, Tuesday evening; Mrs. T. E. King, Saturday afternoon; Thursday evening supper guests were Mr. and Mrs. Cliff Brown of Kamiah and Mrs. Jim Reece; Friday Mr. and Mrs. Richard Hedeon and son of Bellvue, Wn., were supper guests. Saturday overnight and Sunday dinner guest was Mrs. Elmer Suddreth of Lewiston.

Wednesday afternoon Mr. and Mrs. M. N. Benjamin visited her sister and husband, Mr. and Mrs. Glen Daggett in Lewiston.

Mr. and Mrs. Ervin Fry and Warren, and Mr. and Mrs. M. N. Benjamin joined other members of their families at the Gary Clear home in Clarkston for a reunion. Rev. and Mrs. B. W. Pressnall, now of Culdesac, were also among the guests.

Mr. and Mrs. M. C. Armitage of Lenore visited his father, T. J. Armitage, Sunday.

Mr. and Mrs. Arlie Armitage visited with her parents, Mr. and Mrs. Walter Benscoter, Sunday.

Thursday evening callers in the Roy Gertje home were Mr. and Mrs. Norman McIntyre of Orofino.

Sunday afternoon visitors of Mr. and Mrs. Roy Gertje were Mrs. Wayne Harris and children of Kendrick.

Mr. and Mrs. Clay King were Sunday dinner guests of Mr. and Mrs. Ray Southwick, Clarkston.

Mr. and Mrs. C. A. Cuddy were Sunday dinner guests of Mr. and Mrs. Henry Davis.

Monday callers in the Rollin Armitage home were T. J. Armitage, Arlie Armitage, Mr. and Mrs. Jack Mustoe, Mrs. Alma Betts, Bonnie Lawrence and Mrs. C. A. Cuddy.

**STAINLESS STEEL
PROTECTS BLADES**

Stainless steel shields are protecting turbine blades in hydroelectric plants from the eroding effects of whirling water, says Alloy Rods Company, York, Pa. Implosive forces created by a partial vacuum formed as water passes over the blades can, in time, make unprotected blades look like sponge cakes. A 1/2-inch minimum thick layer of weld metal from new fabricated stainless steel electrodes provides the blades with an armor coating to combat these destructive forces.

THANK YOU

I wish to thank all my friends and neighbors for their cards, flowers and visits during my stay in the hospital — and for their help while convalescing at home. — Mrs. Elmer Lohman. 48-1

**Today's Best Buys
AT OUR
CLOSE OUT DISCOUNT SALE**

- PILLOW CASES**
ASSORTED AND PLAIN COLORS
PAIR 98c
- TURKISH TOWELS**
BATH SIZE
59c
- HAND TOWELS**
39c
- MEN'S CASHMERE SOXS**
DARKS AND NATURAL
PAIR 53c
- MEN'S CRUSHER HATS**
RED
EACH \$1.79
- ONE LOT LADIES' OXFORDS**
SEE THESE AT
\$1.98
- RUBBER FOOTWEAR**
LESS 10%

N. B. LONG & SONS

PHONE 5951 SINCE 1908
ONG & SONS N. B. LONG & SONS N. B.

SHORT'S FUNERAL CHAPEL
MOSCOW, IDAHO PHONE 882-4534

Frozen Foods of All Kinds — Blewett's Grocery

**HILLS BROS
COFFEE**



1-Lb. Can	79c
2-Lb. Can	\$1.59
3-Lb. Can	\$2.29
10-Oz. Instant	\$1.39

MONTH END SPECIALS

ARMOURS FRANKS — 2-Lbs.	\$1.09
DUNCAN HINES LAYER CAKES — 3 Packages	\$1.00
GOLDEN GRAIN COTTAGE CHEESE 2 Pints	49c
VELVEETA CHEESE — 2-Pound Package	\$1.09
KRAFT MARSHMALLOW CREAM or	
KRAFT MINATURE MARSHMALLOWS 4 for	\$1.00

BLEWETT'S CASH GROCERY
PHONE 289-4921 KENDRICK

HILLS BROS COFFEE-LOVERS SPECIALS



1-Lb. Can	79c
2-Lb. Can	\$1.69
3-Lb. Can	\$2.29
10-Oz. Jar Instant	98c

**STANDBY CAKE MIXES — White,
Devils Food or Yellow, 4 for** \$1.00

**ROYAL CLUB GREEN BEANS —
303 Tins — 4 for** \$1.00

**ROYAL CLUB FRUIT COCKTAIL —
303 Tins — 3 for** 83c

**ROYAL CLUB CREAM CORN —
303 Tins — 4 for** 85c

Kendrick Table Supply
"Your Friendly Store"
JIM TRAVIS PHONE 289-5741



**DID YOU KNOW YOU CAN GET
BEAUTIFUL CHINA
FOR AS LITTLE AS
\$1.29
PER PLACE SETTING
WHEN YOU BUY STANDARD GASOLINE
AT THIS STATION?**

*Come In And See This Beautiful and
Distinctive Island Rose China*



**WE DELIVER PHONE 289-5711
KENDRICK GARAGE INC.**

N. B. LONG & SONS N. B. LONG & SONS N. B. LONG & SONS N. B. LONG & SONS N. B.